

5MP 4ch/8ch/16ch Network Video Recorder

PIXEL **MASTER NVR**

NR-4M62 / NR-8M62 / NR-16M62

| USER'S MANUAL

Before connecting, operating or adjusting this product,
read this instruction booklet carefully and completely



Copyright

This manual without the manufacturer's approved copy and reprinted partially or in full, or translated into another language is prohibited.

Limitation of Liability

This product is designed to prevent fire and theft is not the main means. We shall not be liable for accidents or damage by using this product can result in liability for accidents or damage

In order to improve the performance of the product without prior notice to the product may be a firmware upgrade.

Content

OVERVIEW

4

- 4 Safety Instruction
- 5 Key Features
- 6 What's included
- 7 Front Panel
- 8 Rear Panel
- 10 Remote Control At a Glance

PLAYBACK

88

- 88 If you want to play

INSTALLATION

12

- 12 HDD Replacement
- 14 Basic Layout
- 15 Connecting to an external device

ARCHIVING

91

- 91 To start the Archive menu

MONITORING

23

- 25 Live Screen At a Glance

WEB VIEWER

94

- 94 What is the Web Viewer?
- 96 Live
- 100 Search
- 103 Setup

SYSTEM SETTING

35

- 35 To move to the System Setup menu
- 36 Camera Setting
- 43 Display Setting
- 48 Audio Setup
- 49 User Setting
- 51 Network Setup
- 56 System Setting
- 64 Storage
- 67 Event Setup

MOBILE VIEWER

122

- 122 Ganzview

RECORD SETTING

76

- 76 To start the Record Setup menu
- 77 Record Setup

ARCHIVE VIEWER

137

- 137 Getting started with the Backup Player
- 139 Backup Player At a Glance

SEARCH

83

- 83 To move to the Search menu while in monitoring
- 83 To move to the Search menu while in playback mode
- 84 Search Settings

APPENDIX

142

- 142 Specification
- 144 Compatible HDD Specifications
- 145 Product Overview
- 146 Troubleshooting (FAQ)
- 147 Open Source License Report on the Product

Overview

Safety Instruction

This product was tested with a UPS to satisfy EN 61000-4-11 test conditions (voltage dips and short interruptions test) under the EN 50130-4: 2011 standard.

The Company shall not have any responsibility for any accident or damage that may incur during the use of the product. For your safety, we provide a few instructions about installation, manipulation, cleaning, assembly/disassembly of the product as below. So please read carefully and comply with the instructions.

Before installation

Comply with the following instructions to prevent a fire, explosion, system failure or electric shock.

- Remove the power supply module before proceeding.
- Check the input voltage (AC100V–AC240V) to the power supply module before connecting it.
- Keep the product away from humidity.
- Ensure that all devices connected to the product should be properly earth-grounded.

In operation mode

Comply with the following instructions to prevent a fire, explosion, system failure or electric shock.

- If you need to open the cover, consult with a service person who could help you do what you want to do.
- Do not connect multiple devices to a single power socket.
- Keep the product away from dust or too much combustible substances (ex: propane gas).
- Do not touch it with wet hand.
- Do not insert a conductor in the vent of the ventilation system.
- Do not apply excessive force to unplug the power cord.

Disassembly & Cleaning

- When cleaning on the surface, use a dry cloth.
- Do not wipe the product using water, paint thinner or organic solvents.
- Do never dismantle, repair or modify the product by your own.

During installation

To prevent an accident or physical injury and to operate NVR properly, please comply with the followings:

- Secure at least 18 centimeter of distance between cooling fan and wall for a proper ventilation.
- Install the product on a flat surface.
- Keep it away from direct sunlight or excessive temperature.

While in use

- Do not apply force to or shake it while using it.
- Do not move, throw away or put excessive force to it.
- Using any unrecommended HDD may cause a system failure. Check the compatibility list and use only compatible HDDs.
{A system failure or data loss caused by an incompatible HDD will void your warranty.}

Key Features

This product allows you to receive audio and video signals from a max of 4/8/16 CH 1080p H.264 network camera before saving them to the internal HDD. Besides, you can also transfer them to an external device that can be monitored on your PC or mobile phone remotely.

- Display the video from up to 4/8/16 CH 1080p network camera in real time (Max 120/240 fps)
- Records 4/8/16 CH 1080p network cameras with high transfer rate (max. 8Mbps, up to 120/240 fps per channel).
- Play up to 4/8/16 CH 1080p video in real time (Max 120/240 fps)
- H.264 BP/MP/HP network camera supported (BP: Baseline profile, MP: Main profile, HP: High profile)
- All channels support PoE hub (provides power to the camera).
- 'Plug & Display' camera connection
- Protect the IP camera via secured closed circuit LAN environment
- Auto notification with self diagnosis (HDD S.M.A.R.T, temperature, network connection status, fan error, etc.)
- Dual streaming supported for a remote display
- Auto resolution & FPS adjustment for a remote service
- External eSATA HDD supported – various search methods (time, event, bookmark and thumbnail)
- Mass storage backup via USB port or FTP server
- Dedicated smart phone applications that can be used with iPhone and iPad or on Android OS
- 1080p Full HD GUI

Overview

What's included



Mouse



Remote Control x1 & Batteries (AAA x2)

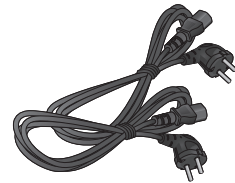

Power Cable x2



DC 12V Adaptor

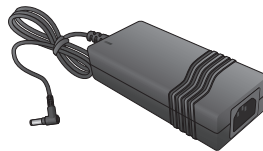

DC 48V Adaptor

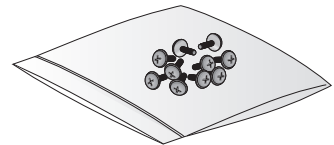

Screws (For fixing HDD)



Adapter cable retainer clip x2

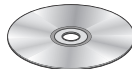

User manual CD

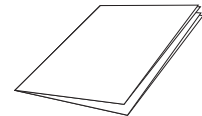

Quick Guide

Optional Components (only for 16-channel NVR)

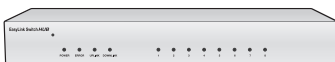

8-channel Extension Hub



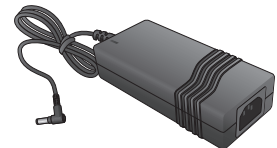

Power Cable



DC 48V Adaptor

✔ This component is only for 16CH NVR and is not included in the basic package.

Front Panel

Name	Description
IR Remote Control Receiver 	Receive the signal from the remote control.
USB 	Used for connecting USB storage or mouse.
Status LED 	Show the status of power, recording or network connection together with the corresponding alarm.

Overview

Overview

Rear Panel

4 CH

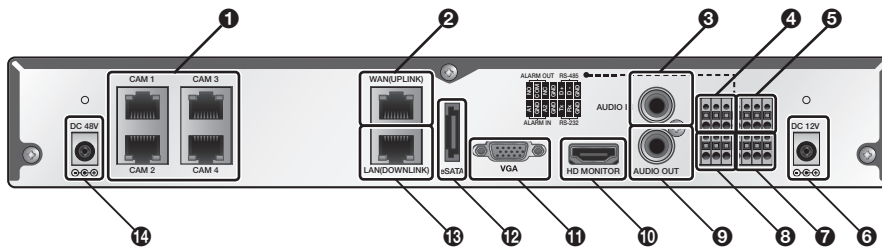

8 CH/16 CH

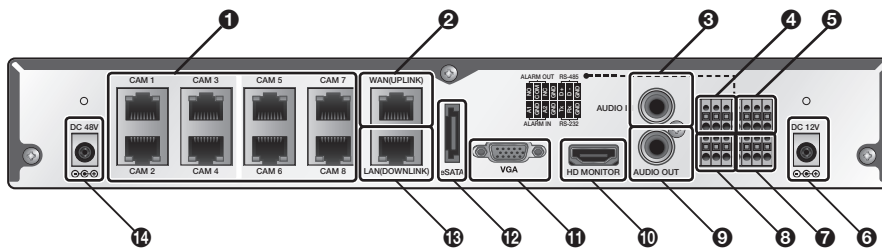

No.	Name	Description
❶	CAM1 ~CAM8	Ethernet ports used for connecting the network camera video and power. ✔ It allows supplying power to camera with PoE.
❷	WAN(UPLINK)	Network port for connection to the Internet, router or hub.
❸	AUDIO IN	Microphone connection port.
❹	ALARM OUT	Alarm output device connection port.
❺	RS-485	Communications port for connecting peripherals such as system keyboard.
❻	DC 12V	NVR power input port. Connect to a 12V adaptor.
❼	RS-232C	Signal connection port for POS and ATM.
❽	ALARM IN	Alarm input signal port.
❾	AUDIO OUT	Port for speaker connection.
❿	HD MONITOR	Port for connecting a full HD(1920x1080) supported monitor. Use the HDMI cable to connect with a 1080p 60Hz monitor.
⓫	VGA	VGA video output terminal.

No.	Name	Description
12	eSATA	Connection port for external SATA storage.
13	LAN(DOWNLINK)	Port dedicated to linking to the NVR network device. (Do not share with other device.)
14	DC 48V	Power input port for the camera (PoE compliant). Connect to a 48V adaptor.

Overview

Remote Control At a Glance

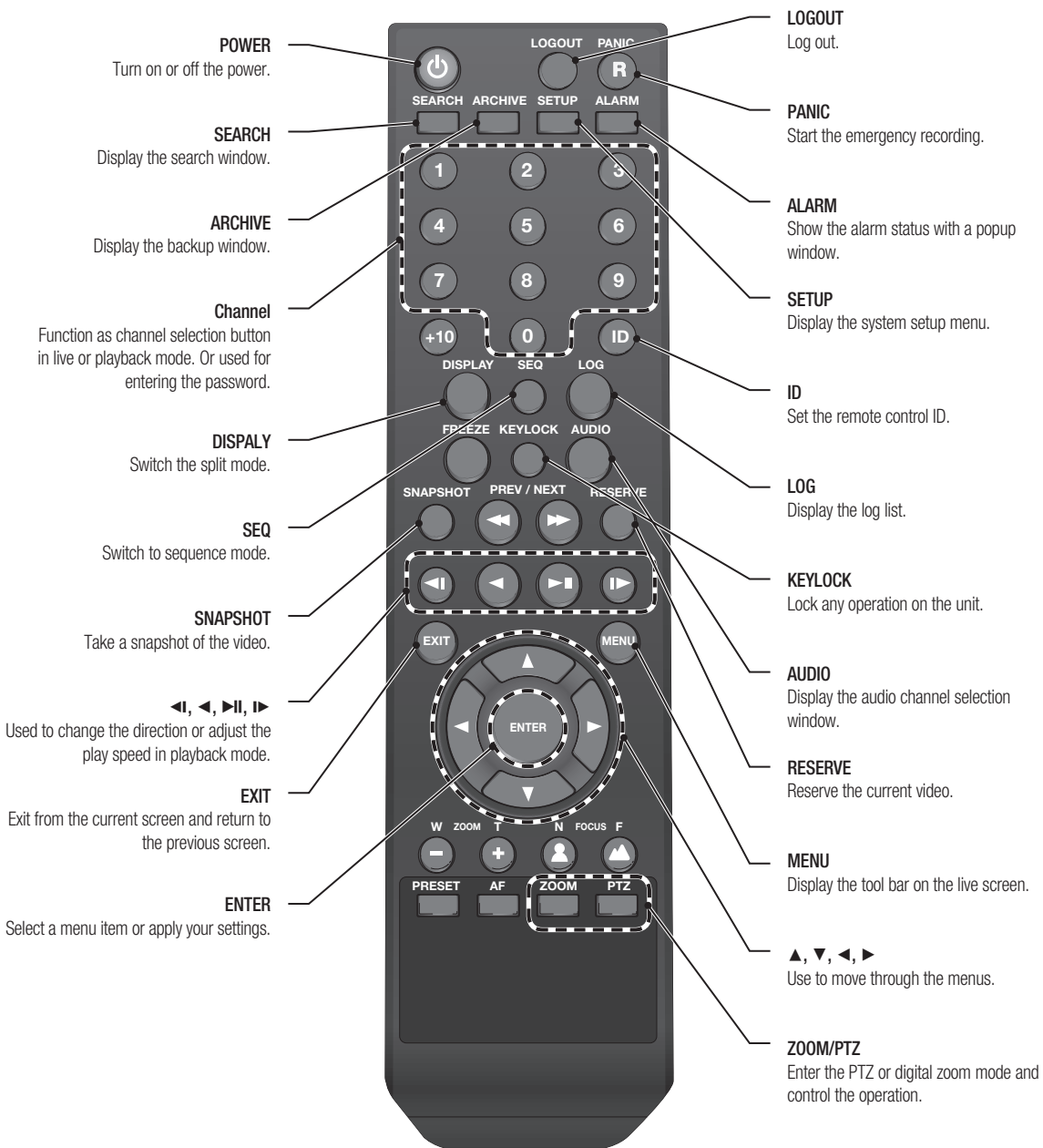

Change the remote control ID

The remote control will be active only if the remote control ID matches with that specified on the NVR.

If multiple NVRs are installed on one place and you have just a single remote control, use the ID button to set the remote control ID. Only the ID-matching NVR can be controlled.

1. From **<SYSTEM>** - **<CONTROL DEVICE>** under the System Setup menu, set the **<REMOTE CONTROLLER ID>** and press **<Apply>**.
Select between 00 and 99. For more details, refer to **<SYSTEM SETUP>**.
The remote control will be active only if the remote control ID matches with that of the NVR's system ID.
2. Press the **[ID]** button on the remote control. The default remote control ID is 00.
3. Use the number buttons to provide a two-digit ID. If you want to enter 01, for instance, enter the number 0 and 1 in sequence. Check if the remote control ID is set properly by manipulating the remote control.
4. To reset the ID to 00, press and hold the **[ID]** button.

Installation

HDD Replacement

User can replace hard disk if existing one reaches its full capacity or becomes problematic.

1. Remove the bracket screw on the bottom of the NVR.

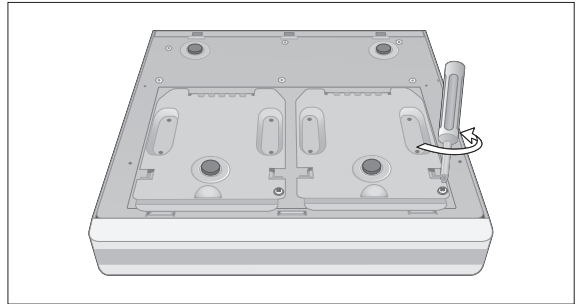

2. Hold the bracket handle in the middle and pull it out to separate the bracket from the main unit.

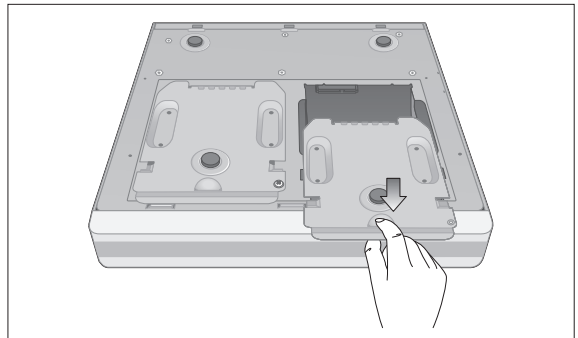

3. Install the HDD on the separated bracket and fasten 4 screws on both sides to secure the HDD.

✓ When installing HDD, make sure to install in the correct direction.

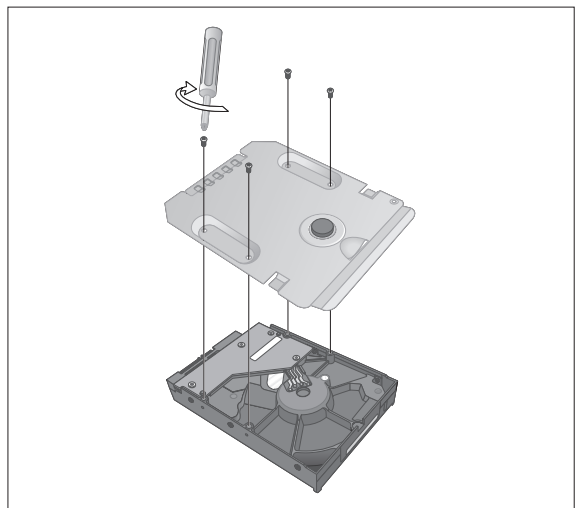

4. Insert the bracket installed with HDD back into the main unit.

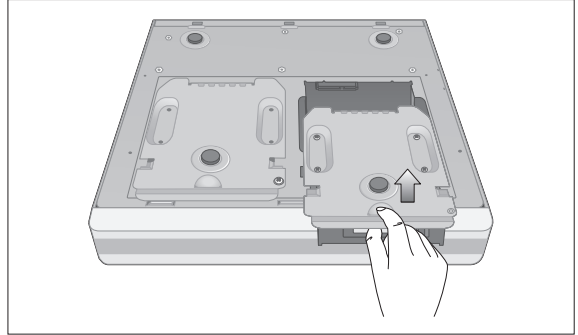

5. Fasten the bracket screw removed earlier.

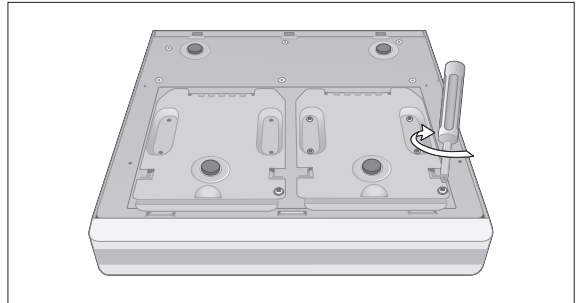

Installation

Installation

Basic Layout

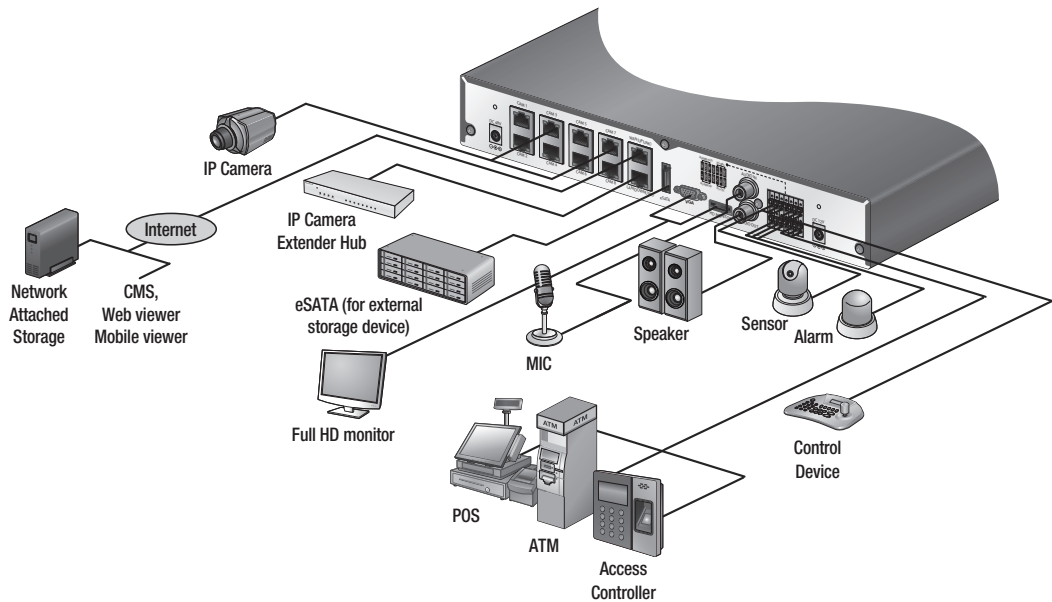

Precautions

To secure recording stability from an overloaded network traffic, hacking attempt or DoS (Denial of Service) attack, only the direct cable connection between camera and NVR is allowed.

- ✓ Using a hub is allowed only for extending single channel for extended transfer range to 100m each.

Any access from an outside PC to the IP camera will be strictly prohibited for the purpose of secure operation.

- ✓ If using the product in 16CH CCTV mode, you need to purchase the Extender Hub to connect individually.

Connecting to an external device

Connecting to the monitor

The product supports 1080p 60Hz monitors with HDMI connection and 1920x1080 resolution VGA monitors only. Connect the HDMI cable between HDMI output port in the bottom rear panel and HDMI port of the monitor, or use the HDMI to VGA cable to connect to the VGA port of the monitor.

Power Connection

Two adaptors are provided: one for NVR operation (DC 12V), and the other for PoE (Power Over Ethernet, 48V).

NVR power connection

Plug the provided DC 12V adaptor in the rear power port of the NVR.

PoE Switching hub power connection

Plug the provided DC 48V adaptor in the rear power port of the NVR.

When done, attach the adaptor cable clip to the rear panel and insert the cable in.

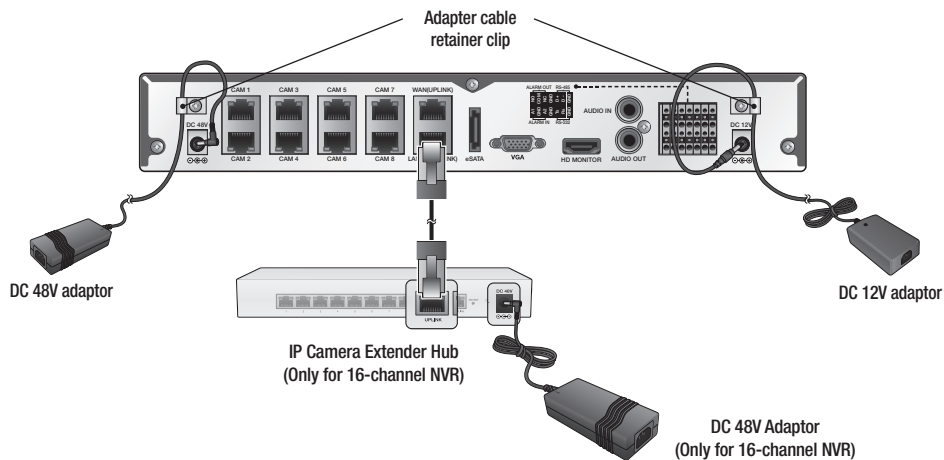

- ✓ If using the product in 16CH CCTV mode, you need to purchase the Extender Hub to connect individually.
- ⚠ Make connection when the power is not applied yet.
- ⚠ Arrange up the cables and be careful not to peel off the cable coating.
- ⚠ Do not place the power cord under the carpet or rug. The power cord is usually earth-grounded. However, even if it's not earth-grounded, do never modify it on your own for earth-grounding.
- ⚠ Do not insert multiple devices in a single power socket. Otherwise, it may cause a power overload.
- ⚠ For stable power supply, this product provides two separate adaptors and two corresponding AC cords by factory default. Make sure all cables are connected properly.

Installation

Connecting the camera

You can connect a PoE-featuring IP camera to the rear [CAM1]~[CAM8], RJ45 port using the CAT5 10/100Mb Ethernet cable without a separate power source.

Connect IP cameras to the [CAM1] ~ [CAM8] ports of the hub, and connect [LAN (DOWNLINK)] port and the hub's [NVR] port with an Ethernet cable to establish connections for channel 9~16 cameras.

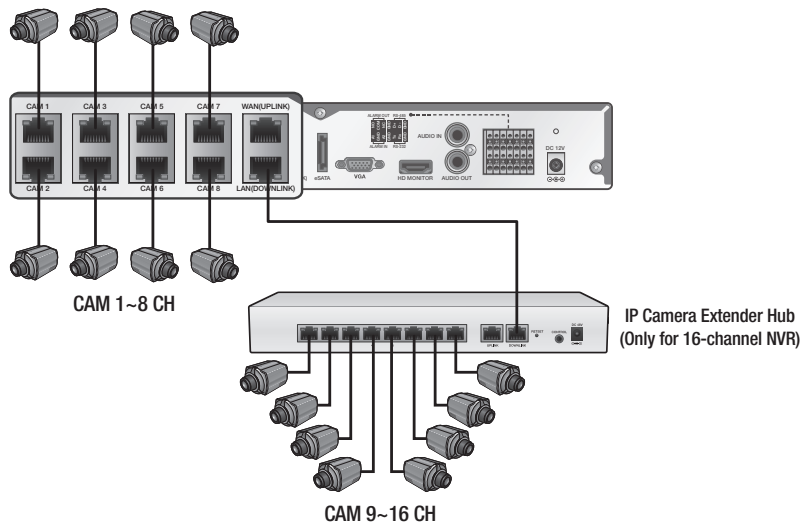

- ✓ If using the product in 16CH CCTV mode, you need to purchase the Extender Hub to connect individually.
- ✓ If the IP camera provides the alarm I/O port or Audio I/O port, you can make alarm or audio connection. For more details, refer to the user manual of the IP camera.
- ❗ The Ethernet connection is effective within 100 meter in distance. Beyond that, you may encounter a data loss or failure to connect to the camera. If you need to make cable connection of longer than 100 meters, use a separate PoE extender for cable extension.
- ❗ The total power consumption of the IP cameras should not exceed the rated power capacity of the 48V PoE adaptor. Beyond that, the video may not be played properly or no video will be displayed at all. If this is the case, use a separate (additional) power source for supplying power to the cameras.
- ❗ Even if total power requirement meets PoE device's power capacity, a camera of more than 15W power requirement per a port cannot be used.
- ❗ Each camera's power consumption can be checked on the network map screen, and total power consumption should consider camera's maximum possible consumption with optional accessories (such as IR / heater device).

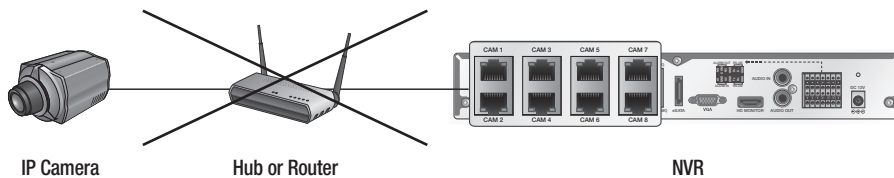

- ❗ For stable operation, a dedicated communication line is established for IP cameras in the same network. This is why network router or hub connection is not allowed.

If the distance between the NVR and IP camera is more than 100m

You may extend the transfer range by connecting a switching hub or PoE device between the Ethernet port and IP camera if desired distance is longer than 100m.

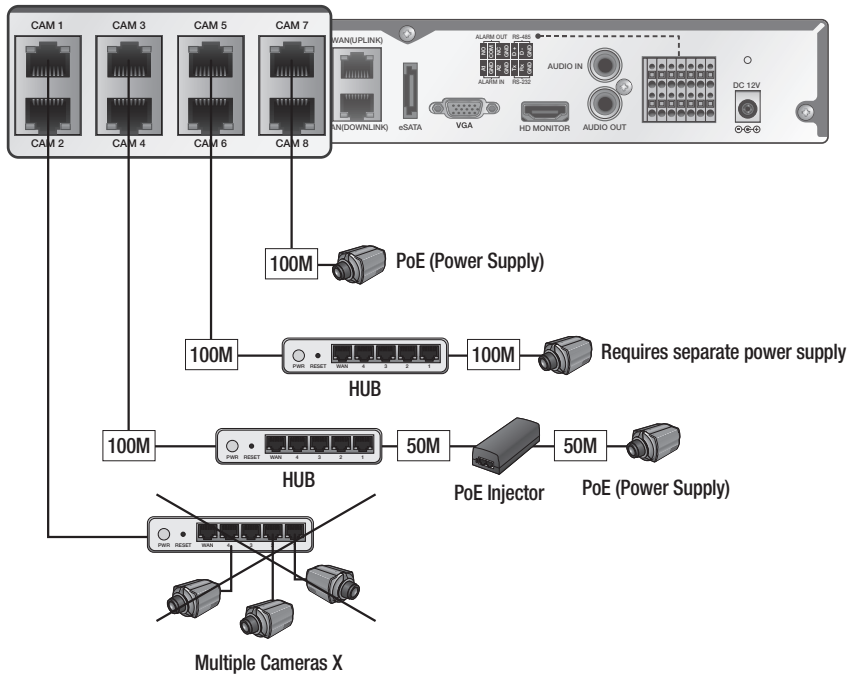

- ✓ Connecting cameras directly to a general switching hub requires camera connected to a separate power supply.
- ✓ A switching hub connected for extending transfer range of a single channel should be connected to one camera only.

Installation

Alarm I/O Connection

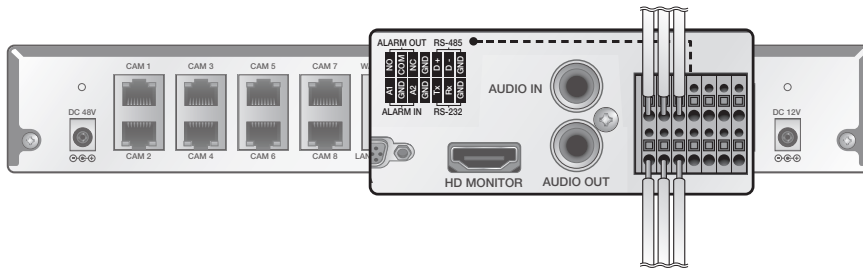

To connect the alarm input signal

Connect the signal line of an alarm input device such as sensor to the rear **[ALARM IN]** port.

1. While pressing and holding the **[A1]** or **[A2]** port button in the rear bottom of the NVR, insert the alarm signal cable in the hole under the button.
2. Insert the grounding wire in the **[GND]** port.
3. To ensure secure connection, release the button and pull out the wire to check if it's not pulled out.
4. To remove the wire, pull it out while holding the upper button.

To connect the alarm output signal

Connect the signal line of an alarm output device to the rear **[ALARM OUT]** port.

1. Check the relay output type of Normal Open or Normal Close before selecting a proper type (N/O or N/C). While holding the **[N/O]** or **[N/C]** button, arrange the alarm signal cable through the hole under the button.
 - N/O(Normal Open) : normally Open but switching to Close if an alarm out occurs.
 - COM : Insert the Relay Common wire.
 - N/C(Normal Close) : normally Close but switching to Open if an alarm out occurs.
2. Insert the Relay Common Wire in the **[COM]** Port.
3. To ensure secure connection, release the button and pull out the wire to check if it's not pulled out.
4. To remove the wire, pull it out while holding the upper button.

Communication Port

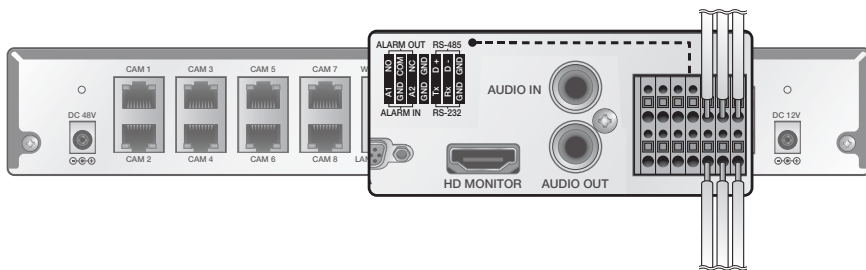

RS-485 Connection

Connect the keyboard controller.

You can connect a text-in device such as POS or ATM. After connecting the control device, be sure to match the connection settings between NVR and device. Make communication settings in **<Control Device>**. (page 61)

1. Use the signal line to make connection between **[D+]** of the rear NVR and **[D+]** of the keyboard controller.
2. Make connection between **[D-]** of the rear NVR and **[D-]** of the keyboard controller.
3. Connect **[GND]** on the rear of the NVR to **[GND]** of the keyboard controller.

✓ For RS-485 connection, refer to the user manual of the keyboard controller.

RS-232 Connection

You can connect a text-in device such as POS or ATM.

For connection of the text-in device, refer to the user manual of the text-in device.

Audio Device Connection

You can connect an audio output device such as speaker amplifier.

Connect the audio input device such as microphone to the rear Audio In port, connect the audio output device such as speaker amplifier to the Audio Out port.

Installation

eSATA Storage

If the internal storage space is insufficient, you can extend your storage capacity by adding an eSATA storage device to the rear eSATA port.

- ✓ eSATA compatibility list
 - Manufacturer : Sarotech
 - Model : C5-US3-N

! Using devices other than recommended eSATA products may cause serious problem.

USB Device

You can connect a USB storage device for backup recorded footages, saving snapshots, firmware update, and exporting/importing user configurations. You can also connect the USB mouse to control all operations of the NVR.

! If you need to connect a USB HDD with a high power consumption, it is recommended to use a separate power source for that HDD.

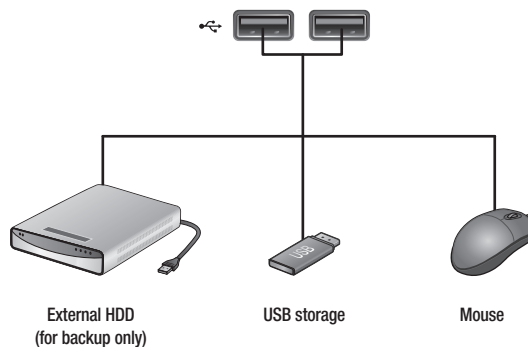

Network Connection

PC connection in the local network

You can connect NVR to a PC in the same network and control or manipulate it on the PC monitor.

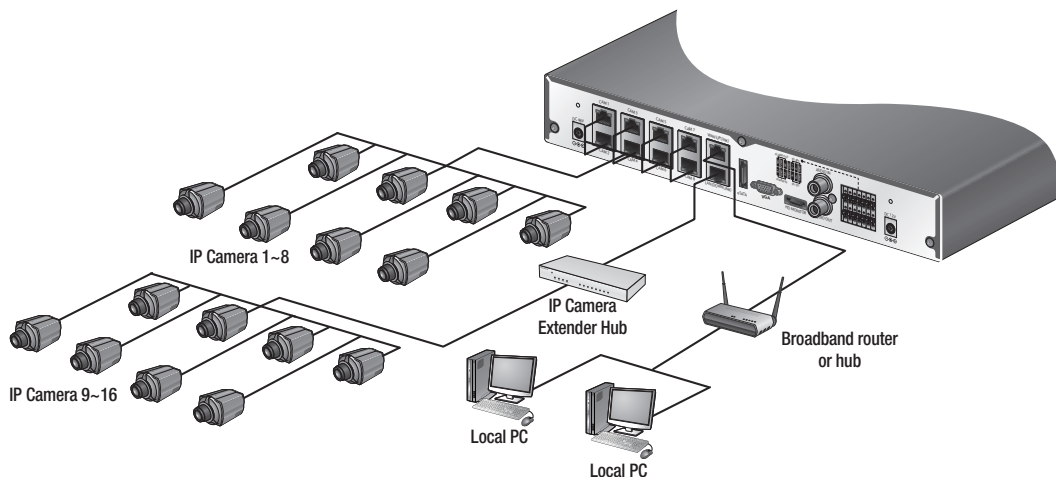

1. Connect the **[WAN(UPLINK)]** port in the rear panel to the router or hub.

2. Connect the local PC to the router or hub.

✓ If using the product in 16CH CCTV mode, you need to purchase the Extender Hub to connect individually.

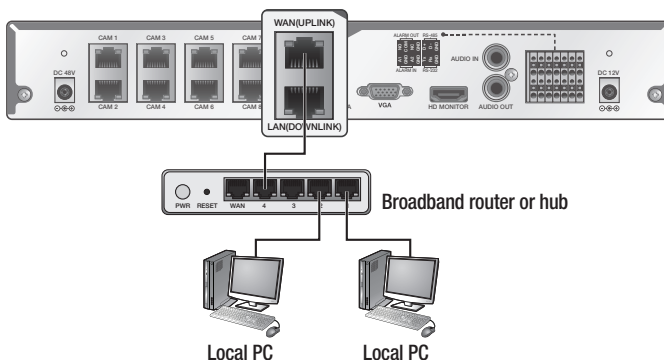

3. Enter the address in the address bar (web browser) of the local PC or of the dedicated software program in the format of **"http://IP address:web service port"**.

(Ex : `http://192.168.0.23:8080`) The web service port is set to 8080 by default. From the Network Setup screen, you can change the port number.

4. Provide the ID and password before logging in. Then, you can view the monitoring screen.

Access ID (factory default) : ADMIN, P/W : 1234.

! For security purpose, change the password before you use the product for the first time after purchasing it.

Installation

PC connection from a remote network

You can connect NVR to a PC or mobile device in the same remote network and control or manipulate it on the monitor of the PC or mobile device.

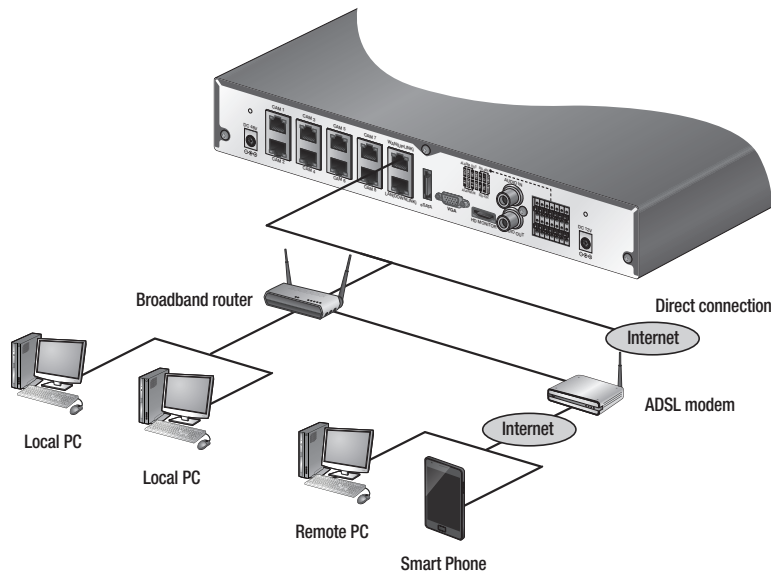

1. Connect the [WAN(UPLINK)] port in the rear panel to the router.

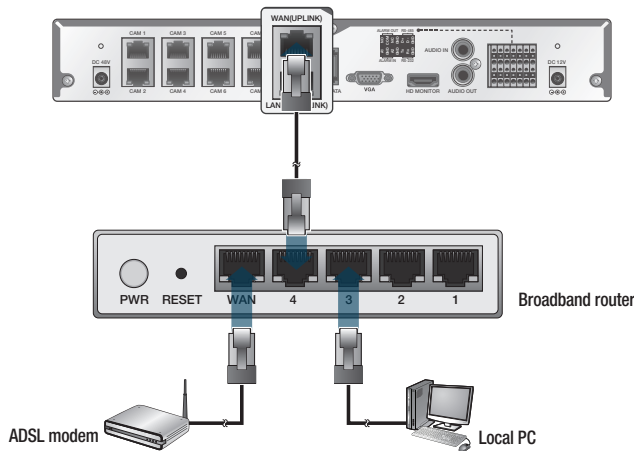

2. Connect the [WAN(UPLINK)] port of the router directly to the fixed IP LAN cable, or connect it to the ADSL modem.
3. If using the router, set the port forwarding and enter the DDNS address in the address bar (web browser) of the remote PC, or of the dedicated software program or mobile phone.
For the IP and DDNS address settings, refer to "Network Setup". (page 51)
4. If the MAC address of the NVR is 00-11-5F-12-34-56 and the web port number is 8080, enter "http://00115f123456.dvrlink.net:8080" in the address bar of the web browser.
If you have renamed DDNS as "mydvr", you can make network connection at http://mydvr.dvrlink.net:8080.

Monitoring

START

1. Connect the adaptor to the 48V PoE power input port in the rear panel of NVR.
 - ❗ Make connection when the power is not applied yet.
2. Connect the adaptor to the 12V power input port in the rear panel of NVR.
3. Turn on the power switch in the rear panel of NVR. With a beep, the logo screen appears several seconds after the front LED turns on.
4. When the booting process is completed, the live screen then the login screen appears.

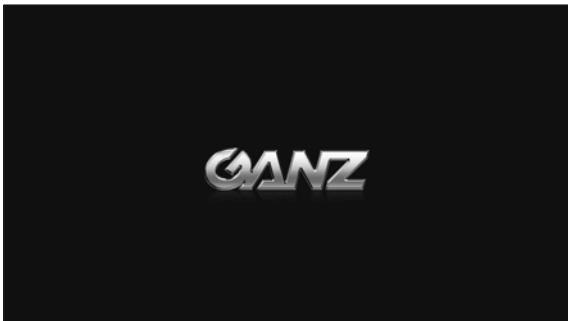

Log In

To manipulate or access the menus of NVR, you should have logged in.

1. When the system starts, the login screen appears.
2. Select a user and provide the password. The default password of the "ADMIN" account is "1234".
3. Click <OK>. If the login information is correct and valid, you will see the live screen.
 - ❗ For security purpose, change the password before you use the product for the first time after purchasing it.



Log Out

To prevent unauthorized access, it is recommended to log out when you leave the screen.

- ✔ Hover the cursor near the bottom of the screen to display the menu.
1. In the monitoring screen, click <MENU> in the bottom left corner of the screen to <LOG OUT>, or press the [LOGOUT] button on the remote control.
 2. Access to SEARCH / ARCHIVING / SYSTEM SETUP / RECORD SETUP / SHUTDOWN will be restricted.

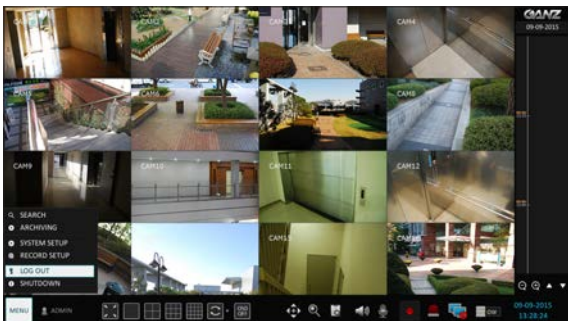

Monitoring

System Shutdown

1. In the monitoring screen, click <MENU> in the bottom left corner of the screen to <SHUTDOWN> the system, or press the [POWER] button on the remote control.
2. Use the virtual keyboard to enter the password.
3. Be sure to turn off the power switch in the rear panel.
 - ! If you turn off the system in an abnormal manner such as removing the power cord while the system is in operation, the disk will have or increase the bad sectors, causing data loss and shortened life cycle of the disk.



Live Screen At a Glance

The live screen largely consists of three components: video window, status bar and timeline zone.



Video Window

















Icons used in the video window.

Item		Description
Camera ID	CAM1	Show the camera ID.
		Displayed if an event recording is reserved.
	C	Display the status of the continuous recording.
Record Mode Icons	A	Display the recording status when an alarm occurs.
	M	Display the recording status when a motion event occurs.
	P	Display the status of the emergency recording.
		The audio signal of the connected camera is outputting.
Audio I/O Icons		The audio signal is transferring to the connected camera via the microphone.
	Motion Detection Icon	

Monitoring





Status Bar

Press the ▼ button on the remote control, or place the mouse in the lower area of the screen to display the status bar.

Item		Description
Menu Button		Select one of the system setup, search and backup menu items before accessing it.
User ID		Show the ID of the user who has currently logged in.
Screen Control Buttons		Edit the screen layout to show the status bar and timeline at all times or only when the mouse cursor hovers on the status bar/timeline.
		Select a split mode.
		Select Auto Sequence or Special Split Mode.
		Display or hide the OSD menu on the screen.
PTZ		Move to the PTZ screen. You can control the PTZ operations of a PTZ-compliant camera on the PTZ screen.
Zoom		Move to the Digital Zoom.
Quick Log		Display the log list of the recent recording events.
Audio Channel Selection Button		You can use the camera supporting the audio input to listen to the audio.
Microphone Channel Selection Button		Select a camera to which the audio signal will be transferred from the connected microphone.
Panic Record		Start the panic recording.
Alarm Indicator		Turns on if an event occurs. It does not turn on if no reaction to the event is yet defined. Click this to check the information of the event that occurred.
Network Connection Status		Check if network connection is made via an external PC or mobile device. Click this to view the details of the concurrent users and to check the network connection status. For more information, refer to " Network Setup ". (page 51)
Disk Space		Show the disk space information. If you have set the disk overwrite mode, it will be displayed "OW" (Over Write) from the start point of the overwriting. Click this to view the details of the disk status. For more information, refer to " Record Setup ". (page 77)
Date & Time		Display the current time and date.

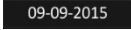
Timeline

Press the [▶] button on the remote control or move the cursor to the right of the screen to display the timeline. Double-click the timeline to move to the video screen. Drag and drop it to make backup or event search for the specified area.

Item		Description
Timeline Date		Display the date of the current timeline. Click this to select a desired date of the timeline.
Expand/Collapse the timeline		Expand or collapse the timeline.
Navigation through Timeline		Navigate through the timeline. You can also use the mouse wheel to do the navigation.
Timeline Bar		Display the recording data with time. The color of each bar indicates the following: <ul style="list-style-type: none"> • Green : Continuous Recording • Red : Alarm Recording • Blue : Motion Recording • Yellow: Panic Recording

Quick Menu

Item	Description
Channel No	Display the number of the current channel.
Play	Start playing the video of the selected channel from the specified time.
Zoom	Zoom the video of the selected channel.
Snapshot Capture	Capture the current live video and save it in the .jpeg format. ✔ Then, you can save the captured video in the HDD or export it to an external USB memory device.
Audio ON/OFF	Turn on or off the audio signal of the selected channel.
Microphone ON/OFF	Turn on or off the microphone signal of the selected channel.
ONE PUSH	Automatically adjusts the focus, within the camera's focus range. It is available only if supported by the connected camera.
CAM CHANGE	You can assign the selected screen to another channel.

Monitoring

Using the status bar in the live mode

Changing Channel

You can change channel in LIVE/PLAYBACK screen. Right-click your mouse at the selected channel, and then click the [CAMCHANGE] to select your desired [CAMXX]. Or you can drag & drop your desired channel into the screen to assign.(ex: Changing the channels of CAM1 and CAM2)

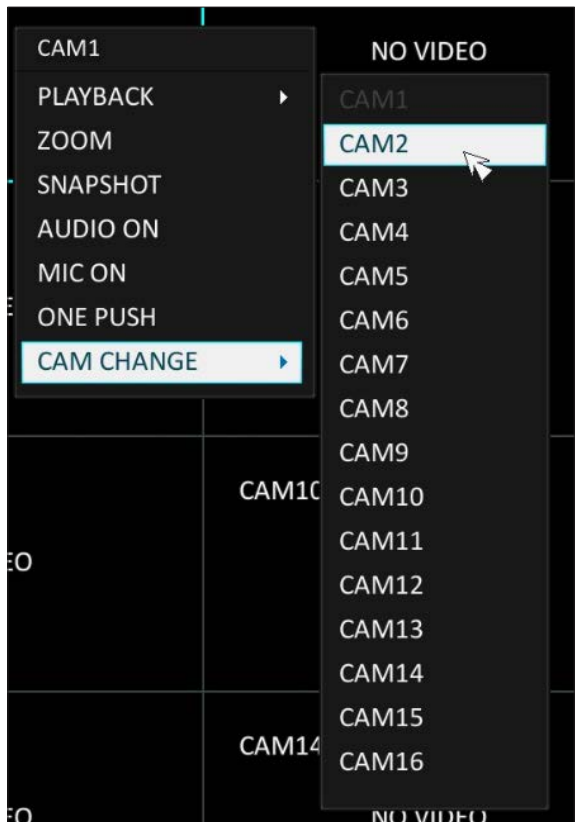

Selecting a split mode

Click a desired split mode from 1, 4, 9, 16, 6 and 8 split screen. Or press the [DISPLAY] button on the remote control until a desired split mode is displayed.

- ✓ 4CH NVR model support only 1- and 4-split screen modes.
- ✓ 8CH NVR model support only 1-, 4-, 9-, 6- and 8-split screen modes.



Auto sequence

Click the Sequence button in the status bar, or press the [SEQ] button on the remote control to perform the specified sequence mode.

You can configure the sequence settings in <SEQUENCE>. For details, refer to "Sequence". (page 45)

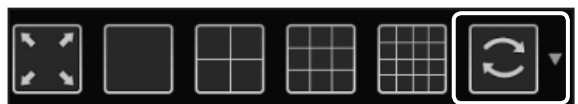

Controlling PTZ

You can control PTZ cameras connected to each channel. Use the mouse to click PTZ button on the status bar, or press the [PTZ] button of the remote control to initiate the predefined sequence.

In PTZ mode, use buttons on the screen to control PTZ or use [ZOOM], [FOCUS] and [PRESET] buttons of the remote control.

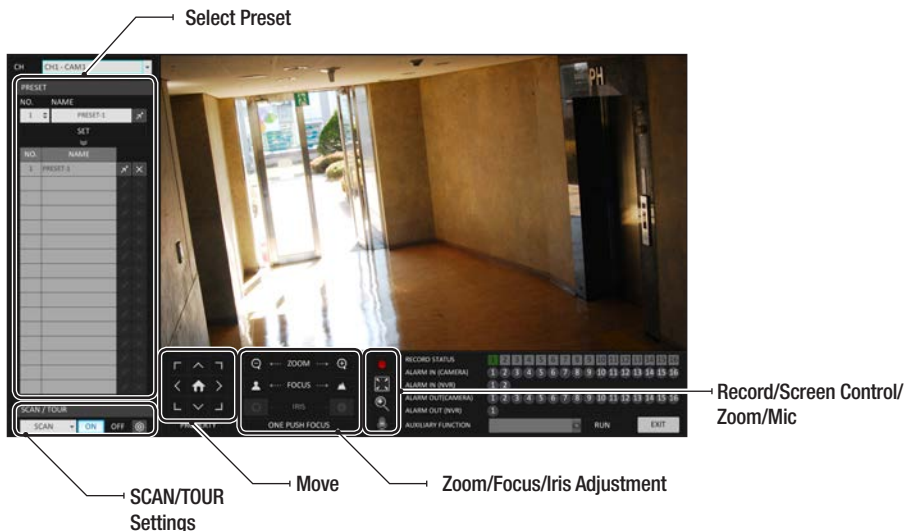

Pan/Tilt Control

Use mouse to rotate the PTZ camera in the direction of up/down/left/right and diagonal directions.

You can control Pan/Tilt with [▲▼◀▶] buttons of the remote control.



Monitoring

Zoom / Focus Control

You can control the PTZ camera for zooming and focus adjustment.

Click **<ONE PUSH FOCUS>** button to adjust the camera's focus automatically.

If the connected camera supports manual iris adjustment, you can adjust the iris setting.

You can control by using **[ZOOM]** and **[FOCUS]** buttons of the remote control.



- Click **<PROPERTY>** and change to a desired setting of the PTZ camera (for auto focus, auto IRIS, pan/tilt speed, zoom speed, focusing speed, iris speed).

✓ Depending on the PTZ camera manufacturer and model, some of the PTZ properties may not be applicable.



- CH : Selects the PTZ camera connected to the NVR.
- PRESET (No. / Name) : You can select the preset number and name.

✓ Up to 255 presets can be selected for a PTZ camera, while up to 16 presets can be registered to one NVR.

- Control the Camera's PTZ while watching the video. Press the **<SET>** button to append the preset.

- : Click the shortcut icon to move to the corresponding PTZ (preset) position.
- : Click Delete icon to delete the corresponding preset.

✓ PRESET: Memorizes the PTZ camera's framing for direct access at a later time.

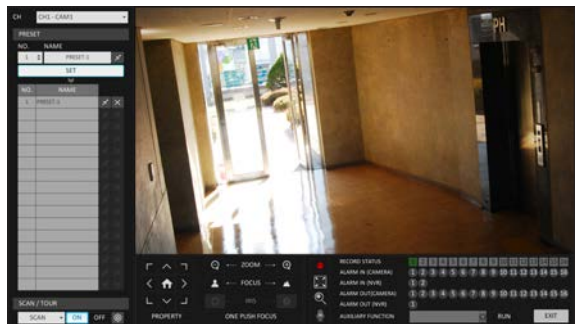

SCAN/TOUR

1. Select <SCAN> and click the <ON> button.
2. Click the <⚙️> icon.



3. Select a user-defined preset and register it.
 - DWELL : Sets the dwell time of 00 seconds before moving to the next preset location.
 - ✓ <SCAN> function patrols two preset positions at the specified speed and interval for back-and-forth monitoring.



4. Select <TOUR> and click the <ON> button.
5. Click the <⚙️> icon.
6. Select a user-defined preset and register it.

- DWELL : Sets the dwell time of 00 seconds before moving to the next preset location.
- ✓ <TOUR> function patrols multiple presets in order (PRESET 1 → PRESET 2 → PRESET 3 → ...) for automated patrolling monitoring.



Monitoring

Digital Zooming

You can enlarge the monitoring screen for better view.

Zooming will enlarge the video of the selected channel. If no channel is selected, channel 1 will be zoomed.

1. Click Zoom in the status bar or move the cursor to a desired channel and right-click it to display the context menu. Select **<ZOOM>**. You can also press the **[ZOOM]** button on the remote control.
2. Move to the zoom control screen. When the menu bar appears in the right bottom, use the buttons to control the zooming.
 - **CH1 - CAM1** : Select a channel to zoom in/out.
 - **🔍** : Zoom out the current (enlarged) image step by step.
 - **🔍** : Enlarge the current image step by step.
 - **Zoom Box** : Use the yellow box to move to or select a desired zooming area.
 - **EXIT** : Exit the zooming screen and return to the live screen.



- ✓ By its nature, digital zooming which interpolates original image to have it enlarged, it may produce less clear image compared to the original. For clearer zooming, it is recommended to use a camera that supports optical zooming.

To check the event log

You can check the log of the events that occurred.

1. Click Log to display the **"EVENT LOG"** window. The log list is sorted with the latest one on top.
2. Double-click a desired log to display the event video. You will move to the play screen of the selected log.

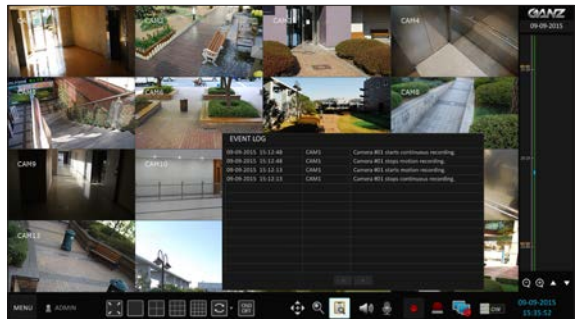

To select an audio input channel

Select a channel from which the audio signal will be received.

- **CHANNEL** : Produces the selected channel's audio, regardless of the split screen mode.
- **LINK TO FULL SCREEN** : When switching the NVR display mode to view one channel (Single Split), it produces the selected channel's audio.
- ✓ A camera supports audio input should be used, and the NVR is connected to a speaker.

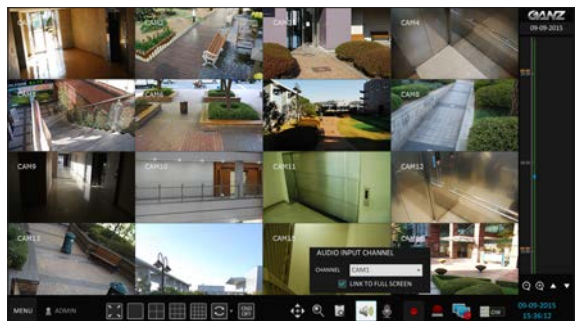

To select an audio output channel

You can select a camera outputting the voice signal from the microphone that is connected to NVR.

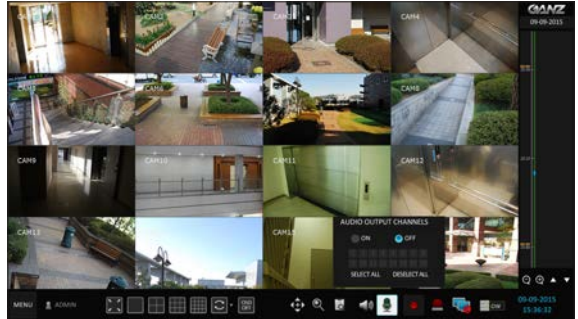

To check the alarm status

You can check the alarm status of each camera. Click <OK> to close the window.

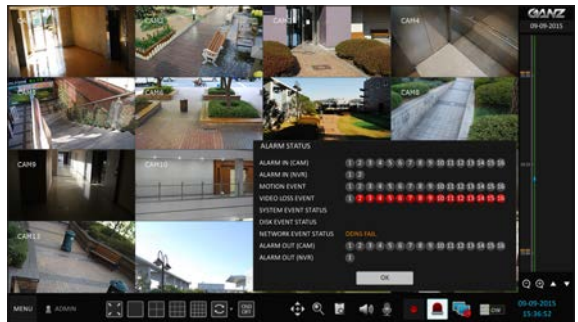

To check the network status

You can check the network connection status. Click <OK> to close the window.

✔ For more information, refer to "Network Status". (page 53).

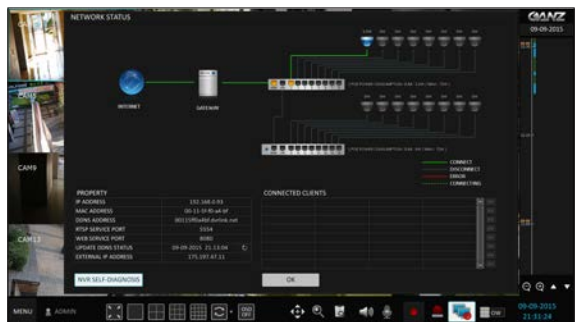

Monitoring

To check the disk status

You can check the storage space of the current disk and check also if there is any problem with the disk. Click **<OK>** to close the window.

- ✓ For more information, refer to "Disk Information". (page 64)

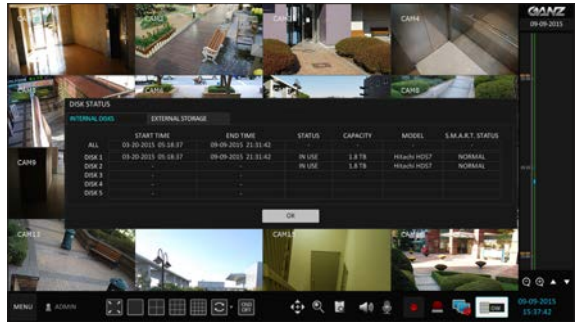

Saving captured snapshots

You can capture the current video screen and save or export to a connected storage device.

1. Select a channel first, and right click to open popup menu, and select **<SNAPSHOT>** menu item, or press the **[SNAPSHOT]** button of the remote control.

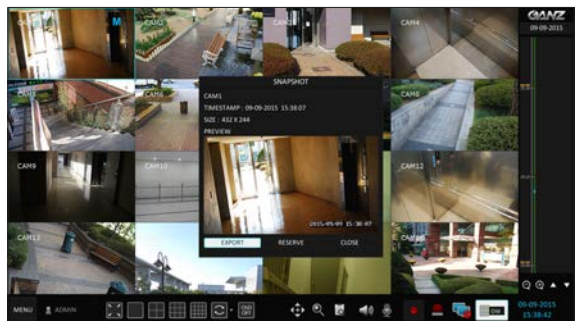

2. Connect a storage device, and click **<EXPORT>** button. To save the captured image onto the built-in HDD, press the **<RESERVE>** button.

- ✓ Saved image can be found in the "Archiving > Reserved data management" and can be backed up. (Page 92)

3. Enter the **<TAG NAME>** and **<MEMO>** and press **<BURN>** or **<ERASE & BURN>** button.

- A progress bar appears and indicates the progress of exporting to storage device.

- **BURN** : Snapshot is stored in the connected USB storage device.

- **ERASE & BURN** : Deletes all files in the connected USB storage and then saves the snapshot.

- ⚠ Note that **<ERASE & BURN>** option erases all data in the USB storage device and will not be restored once deleted..

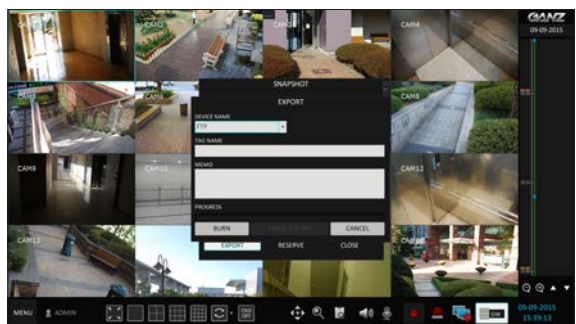

System Setting

To move to the System Setup menu

How to use the mouse

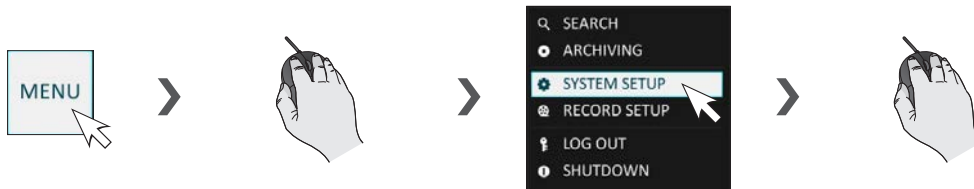

How to use the remote control 1

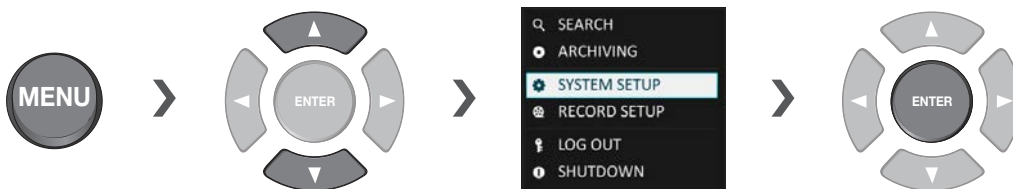

How to use the remote control 2



System Setting

Camera Setting

You can configure the camera settings on the NVR screen regarding the camera title, image, hide/show, motion and PTZ.

Camera Title

You can change the camera ID that is displayed on the screen.

1. From <SYSTEM SETUP> - <CAMERA>, select <CAMERA TITLE>.
2. Use the [▲▼◀▶/ENTER] buttons on the remote control or use the mouse to select a channel that you want to rename.
Alternatively, simply double-click the camera to rename from the top left corner.

✓ Up to 12 alphanumeric letters can be entered.

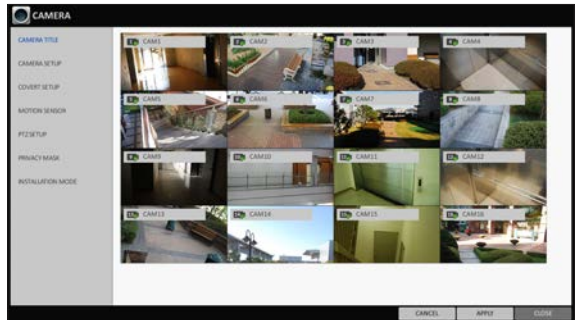

3. With the virtual keyboard that appears, enter a camera title and click <OK>.
4. To apply the change, click <APPLY> in the bottom of the screen.
5. When done, press the [EXIT] button on the remote control or click <CLOSE> in the lower screen to return to the previous menu.

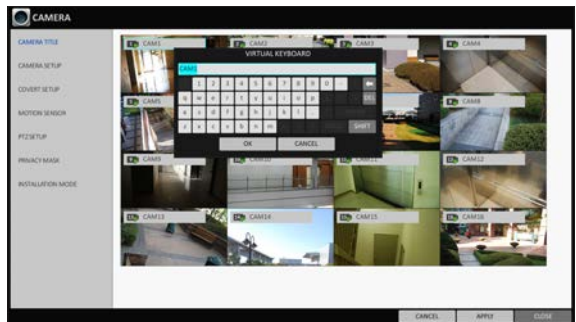

Camera Setup

Adjust the brightness, contrast, color and quality for each channel to your preference.

1. From <SYSTEM SETUP> - <CAMERA>, select <CAMERA SETUP>.
2. Use the [▲▼◀▶]/ENTER buttons on the remote control or use the mouse to set each option of the camera setup menu.
 - **IMAGE SETTINGS** : Configures detailed image capturing setup for the camera.
 - **EXPOSURE** : Controls the camera's exposure adaptively to ambient lighting condition of installed location.
 - COPY SETTING TO : You can equally apply the settings to the camera(s) in different channel(s).
 - POE POWER OFF : You can cut the POE power for the corresponding channel.
 - **FOCUS COMPENSATION** : Select <On> to switch between Day and Night mode and adjust the focus automatically.
 - **STREAM SETUP** : You can specify the camera's codec, resolution and other properties.
 - **DIRECT CONFIGURE** : Connects to the IP camera via web to manipulate directly.
3. To apply the change, click <APPLY> in the bottom of the screen.
4. When done, press the [EXIT] button on the remote control or click <CLOSE> in the lower screen to return to the previous menu.

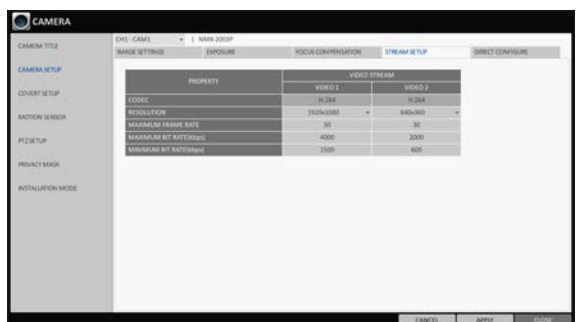
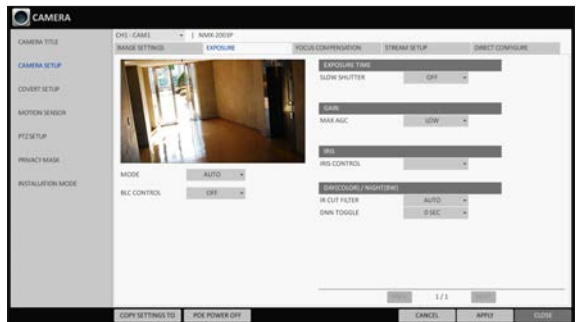

System Setting

Direct Configuration

Direct configuration support may differ from camera manufacturers.

If supported by the camera, you can access the camera via web to directly manipulate the camera, for updating the camera's firmware for example.

For cameras not supporting direct configuration over web, use the computer connected to the camera for configuring it.

1. Select **<DIRECT CONFIGURE>** from the **<CAMERA SETUP>**.
2. Press the **<START>** button to display a popup message.
 - ✓ Recording stops for the corresponding channel during manipulating the camera.



Covert Setup

You can set to hide the camera video so that a specific user or user group can not view. Set a channel(s) that you want to hide from a specific user or user group.

1. From **<SYSTEM SETUP>** - **<CAMERA>**, select **<COVERT SETUP>**.
2. Use the **[▲▼◀▶/ENTER]** buttons on the remote control or use the mouse to select a covert channel(s) from a specific user group.
 - **ADMIN, MANAGER, USER** : Set them to **<ON>**.
The selected channel will be covert from the applicable user account.
 - **LOG OUT** : Set it to **<ON>**. When the user logs out, the current channel will be set to a covert channel.
 - **SHOW AS** : Sets how to display video of the **<COVERT CHANNEL>** channel.
 - **NO VIDEO** : Appears to have no video for the channel.
 - **COVERT** : Shows nothing for the Live screen only.



✓ If **<NO VIDEO>** or **<COVERT>** is specified, the camera title is reset to the default value.(ex:CAM##)

3. To apply the change, click **<APPLY>** in the bottom of the screen.
4. When done, press the **[EXIT]** button on the remote control or click **<CLOSE>** in the lower screen to return to the previous menu.

✓ To change the covert settings from user group to user, move to the **<USER>** menu and make necessary changes. (page 49)

Motion Sensor

Set the motion sensor of the camera so that it can detect a motion event.

- From <SYSTEM SETUP> - <CAMERA>, select <MOTION SENSOR>.
- Use the [▲▼◀▶/ENTER] buttons on the remote control or use the mouse to specify the use of each option item.
 - ▶ **ACTIVATION** : Set whether to activate motion sensor of the camera channel.
 - ▶ **MOTION MARK** : Set to <ON> to display motion detection indicator on the corresponding channel's video.
- To apply the change, click <APPLY> in the bottom of the screen.
- When done, press the [EXIT] button on the remote control or click <CLOSE> in the lower screen to return to the previous menu.



Motion Area Setup

Setting the motion area may differ depending on the camera model. Below is a typical setting of the motion area.

- Click <AREA SETUP> to move to the motion area setup screen.
- Select a channel to define a motion detection area.
- Use the arrow buttons to move to a desired block and press [ENTER]. The area setup will begin. Then, use the arrow buttons to specify the area.
 - ✓ Alternatively, you can use the drag-and-drop method to specify or release the area as using mouse.
- If you select the specified area again, it will be released.
- You can set the channel's detection period for day and night, sensitivity, minimum number of blocks and interval.
 - ▶ **DAYTIME** : specify the time period that will be considered as daytime.
 - ▶ **SENSITIVITY** : Sets the sensitivity level for detection during the day time or night time. The higher the level, the higher the detection sensitivity.
 - ▶ **MIN BLOCK** : 1(High) ~ 10(Low) - The lower the number is, the higher the sensitivity level becomes.
 - ▶ **SELECT ALL** : Select all area as motion detect area.
 - ▶ **DESELECT ALL** : Deselect all selected area.
 - ✓ Images recorded in a low contrast scene such as at night cause severe noise, triggering the motion event too often.
 - ✓ If this is the case, reduce the nighttime sensitivity to a degree.
 - ❗ The above options such as <SENSITIVITY> and <MINIMUM BLOCKS> and how to set the motion area may be restricted depending on the specification of the connected camera.

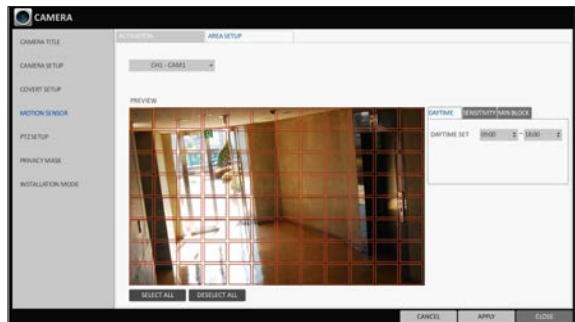

System Setting

PTZ Settings

You can set the camera ID, protocol, baud rate and data transmission speed for each channel.

- From <SYSTEM SETUP> - <CAMERA>, select <PTZ SETUP>.
- Use [▲▼◀▶/ENTER] buttons of the remote control or mouse to set the address (ID), protocol and data transmission speed for each channel.
 - RS-485 : You can manually configure RS-485 communication connection to the pan/tilt base (PT driver) of IP Box type camera or motorized zoom lens. Check to enable editing <ID>, <PROTOCOL> and <BAUD RATE> submenu items.
 - IP PTZ cameras and others that transfers PTZ control signal over IP network require no separate settings.



- To apply the change, click <APPLY> in the bottom of the screen. Once clicked <APPLY> button after changing settings, a restarting message pops up. Click <Yes> to restart the system automatically.
- Once the setup is complete, press the [EXIT] button of the remote control or click <CLOSE> button on the bottom to display a confirmation dialog. Click <CANCEL> to return to the previous menu.

Enabling Privacy Mask

For privacy purposes, you can specify masking area for a selected camera's video.

- From <SYSTEM SETUP> - <CAMERA>, select <PRIVACY MASK>.
- Use [▲▼◀▶/ENTER] buttons of the remote or the mouse to set channels enabled, mask color and its area.
 - ACTIVATION : Turns on or off the motion detection sensor in the specified privacy area.
 - MASK COLOR : Select the color of the masked area, which will be displayed on the monitor.
- To apply the change, click <APPLY> in the bottom of the screen.
- When done, press the [EXIT] button on the remote control or click <CLOSE> in the lower screen to return to the previous menu.

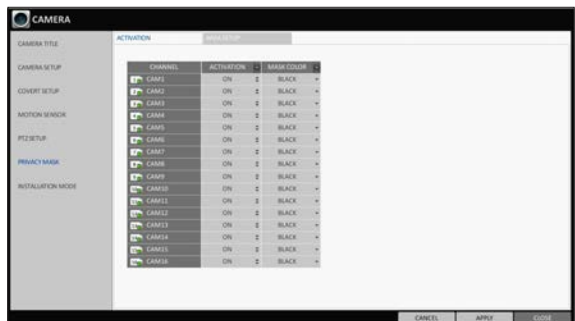

Setting the Privacy Masking Area

You can specify the privacy masking area.

1. Click on the <AREA SEUPUP> tab on the right side to display the area setup page.
2. When using the remote, press the [Select] button to show the selector first.
3. Use direction keys to move to the desired channel, and press the [Select] button to begin area setup. Use direction keys to set the masking area. When using the mouse, hold the mouse left button and drag to set or cancel the masking area.
4. Selecting masked area again will exclude the corresponding block from the masking area.

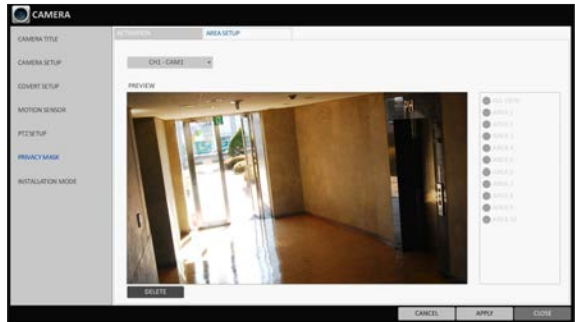

Installation Mode

The network accessibility to the camera is defined by the camera's operation mode.

1. From <SYSTEM SETUP> - <CAMERA>, select <INSTALLATION MODE>.
2. Use [▲▼◀▶/ENTER] buttons of the remote or the mouse to select one from CCTV Mode (Recommended) and OPEN Mode (Advanced).

✔ Setting to the "Open Mode" allows access to all ports including the camera's connection port from the external network. Accordingly, the camera's network transfer and transferred video's quality will be affected by the relevant communication devices and environment.

✔ CCTV mode is set for camera installation mode by default and both main body and hub (optional, 16CH) support the PLUG & PLAY function. (You cannot use the CCTV mode mixed with the OPEN mode.)

✔ In case 16CH model is set to OPEN mode, only the electrical power is supplied to the 8 cameras connected to main body and the Plug & Play function is not supported.

3. To apply the change, click <APPLY> in the bottom of the screen.
4. When done, press the [EXIT] button on the remote control or click <CLOSE> in the lower screen to return to the previous menu.

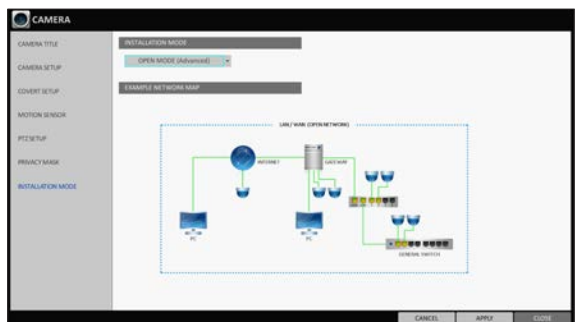
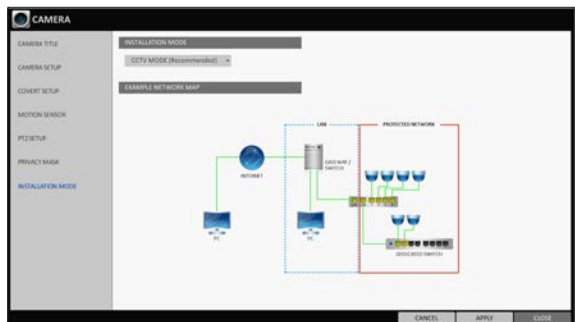

System Setting

Configuring the OPEN Mode Cameras

1. Setting to the <OPEN MODE> will restart the system as it switches the network configuration.
2. From the <INSTALLATION MODE> menu in <CAMERA>, press the <ADD CAMERA> button.



3. You can automatically search with <AUTO SCAN> for cameras available on the network, or provide IP address or the hostname with <SPECIFIC IP / HOST NAME> to manually search a camera.

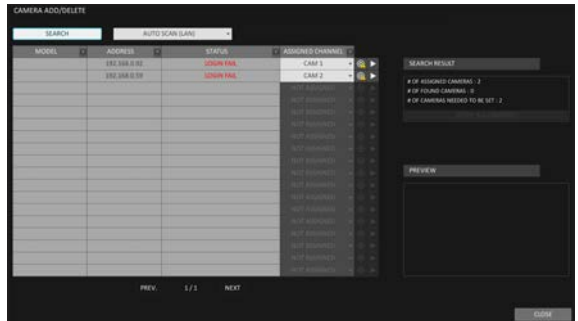

4. Assign a channel number to the camera searched, and press <Ⓜ> to add the camera.
5. When done, press the [EXIT] button on the remote control or click <CLOSE> in the lower screen to return to the previous menu.

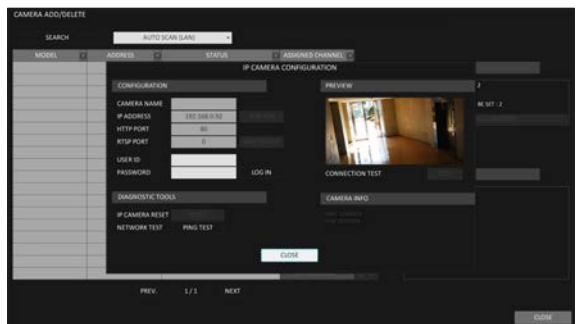

Display Setting

You can configure the display settings regarding the OSD menus, monitor, sequence and POS/ATM.

OSD

Configure the settings for the time, title, boundary, icon and language that will be displayed on the screen.

1. From <SYSTEM SETUP> - <DISPLAY>, select <OSD>.

2. Use the [▲▼◀▶/ENTER] buttons on the remote control or use the mouse to set each option of the OSD item.

- › CAMERA TITLE : specify the display of the camera title on the screen.
- › RECORDING MODE ICON : specify the display of the record mode icon on the screen.
- › AUDIO ICON : specify the display of the audio icon on the screen.
- › STATUS BAR ON FULL SCREEN MODE : select to show or hide the status bar in full screen mode.
 - AUTO HIDE : place the cursor in the lower area of the screen to display the status bar. If moving the cursor up, the status bar will disappear.
 - ALWAYS ON : The status bar will be displayed at all times.
 - 5 SEC ~1 MIN : If no mouse movement is detected for from 5 seconds to 1 minute, the status bar will disappear.
- › TIMELINE ON FULL SCREEN MODE : select to show or hide the timeline in full screen mode.
 - AUTO HIDE : place the cursor in the right corner to display the timeline. If moving the cursor to the left, the timeline will disappear.
 - ALWAYS ON : The timeline will be displayed at all times.
 - ALWAYS OFF : The timeline will not be displayed.
- › BORDER LINE : specify the display of the cross-border between channels in a split mode.
- › BORDER COLOR : select a color for the border.
- › USER NAME : specify the display of the currently logged-in users on the status bar.
- › LANGUAGE : select a menu display language.

3. To apply the change, click <APPLY> in the bottom of the screen.

4. When done, press the [EXIT] button on the remote control or click <CLOSE> in the lower screen to return to the previous menu.



System Setting

Monitor

If you change from monitoring mode to sequence, you will have to set the interval of the sequence.

1. From <SYSTEM SETUP> - <DISPLAY>, select <MONITOR>.
2. Use the [▲▼◀▶/ENTER] buttons on the remote control or use the mouse to set a sequence interval for auto mode to 1 through 60 seconds.
3. The resolution of the display screen is set by setting the monitor resolution.
 - AUTO : Automatically selects the maximum resolution supported by the connected monitor.
4. To apply the change, click <APPLY > in the bottom of the screen. Once clicked <APPLY > button after changing settings, a restarting message pops up. Click <OK> to restart the system automatically.
5. When done, press the [EXIT] button on the remote control or click <CLOSE> in the lower screen to return to the previous menu.



Sequence

Select a split mode for the sequence, and also select a list of active items when the sequence is performed.

1. From <SYSTEM SETUP> - <DISPLAY>, select <SEQUENCE>.
2. Use the [**▲▼◀▶**]/ENTER] buttons on the remote control or use the mouse to add a sequence or change the settings of the existing sequence.
 - ACTIVATION : select a list that you want to activate the sequence for. Only one list will become active.
 - ADD : add a sequence.
3. To apply the change, click <APPLY> in the bottom of the screen.
4. When done, press the [EXIT] button on the remote control or click <CLOSE> in the lower screen to return to the previous menu.



To add a sequence

1. Click <ADD> in the bottom of the screen.
2. When the "ADD" dialog appears, enter a title using the virtual keyboard.
3. Enter the name of the sequence and click <SAVE>.



System Setting

4. When the "ADD VIEW TYPE" dialog appears, click <ADD VIEW TYPE>.
5. When the "SEQUENCE SETUP" dialog appears, select a split mode that you want to add from <VIEW TYPE>.
6. If the selected split mode is displayed on "VIEW CONFIGURE", select a channel you want to display in each split screen.
7. Click <CONFIRM>.
The set sequence mode is confirmed and will be added to the Add Sequence list in order.
8. When done, click <CLOSE> in the bottom of the screen.
After the sequence type is saved, you will return to the previous screen.
9. Right-click on the new sequence, or press the [ENTER] button on the remote control to edit or delete it.
 - ✓ 4CH NVR model support only 1- and 4-split screen modes.
 - ✓ 8CH NVR model support only 1-, 4-, 9-, 6- and 8-split screen modes.



To edit a sequence

1. Click the <EDIT> button on the right side of listed Sequence to be edited.
2. The "EDIT" dialog appears.
3. Use the [▲▼◀▶]/ENTER buttons on the remote control or use the mouse to edit the selected sequence.
 - SEQUENCE TITLE : enter a new sequence name.
 - ACTIVATION : specify the use of the sequence.
 - MODIFY : change the settings of the sequence mode.
 - DELETE : delete the selected sequence list.
 - CANCEL : cancel the changes.
4. Pressing the <MODIFY> button will display the Edit Sequence window.
5. To change the existing settings, select a screen mode that you want to edit and right-click to display the context menu. Then, select <MODIFY>.
6. When done, click <CLOSE> to close the window.
7. To apply your changes, click <APPLY>.

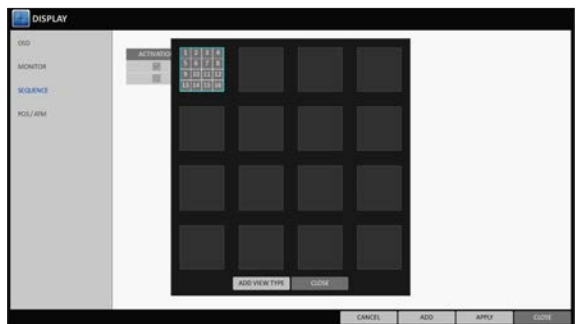

POS/ATM

You can change the settings required to interlock the POS/ATM device connected to NVR.

1. From <SYSTEM SETUP> - <DISPLAY>, select <POS/ATM>.
2. Use the [▲▼◀▶/ENTER] on your remote control or use the mouse to change the POS/ATM settings.

- DISPLAY MODE : You can select the screen where the data entered from POS/ATM are displayed.
 - OFF : Nothing is displayed on screen.
 - BOTH : Both LIVE and PLAYBACK screens are displayed.
 - LIVE : The POS/ATM data are displayed on the LIVE screen.
 - PLAYBACK : The POS/ATM data are displayed on the PLAYBACK screen.



- POSITION : Select LEFT or RIGHT for the screen position.
- FONT SIZE : Select SMALL, MEDIUM or LARGE for your desired font size.
 - ✓ The font size is applied to a single split screen only.
- FONT COLOR : Select WHITE, GRAY, YELLOW, BLUE, GREEN or RED for your desired font color.
- DWELL TIME : You can set how long the data is displayed on screen.
 - UNTIL NEXT : Keep the data displayed on screen until the next data are input.
 - 1~60SEC : The data are displayed for the specified time.
- SCROLL TYPE : Set the scroll type for screen.
 - CLEAR : Display the screen without scrolling.
 - ROLL UP : Display the screen with roll-up type scrolling.
- HIGHLIGHT TEXT : Select whether to activate the highlighted text or not before entering the text and specifying its color.
- EXCLUDE TEXT : Select whether to activate the excluded text or not before entering the text.
 - ✓ The POS data are displayed only in 1-, 4-, 6-, and 8- split screen.

3. To apply the change, click <APPLY> in the bottom of the screen.
4. When done, press the [EXIT] button on the remote control or click <CLOSE> in the lower screen to return to the previous menu.

System Setting

Audio Setup

You can configure audio and signal beeps.

Audio

You can select the default audio channel and configure network audio transmission.

1. From <SYSTEM SETUP> - <AUDIO>, select <AUDIO>.
2. Use the [▲▼◀▶/ENTER] buttons on the remote control or use the mouse to select an item that you want to edit.
 - DEFAULT LIVE AUDIO CHANNEL : select an audio channel to monitor on the live screen.
 - NETWORK AUDIO TRANSMISSION : decide if NVR transfers the audio signal to the remote client.
 - RECEIVE NETWORK AUDIO : decide if NVR receives the audio signal from the remote client.
3. To apply the change, click <APPLY> in the bottom of the screen.
4. When done, press the [EXIT] button on the remote control or click <CLOSE> in the lower screen to return to the previous menu.



Buzzer output

You can set to output the buzzer if you manipulate the remote control.

1. From <SYSTEM SETUP> - <AUDIO>, select <BUZZER>.
2. Use the [▲▼◀▶/ENTER] buttons on the remote control or use the mouse to select an item that you want to edit.
 - REMOTE CONTROL : specify the output of a beep when you press a button on the remote control.
3. To apply the change, click <APPLY> in the bottom of the screen.
4. When done, press the [EXIT] button on the remote control or click <CLOSE> in the lower screen to return to the previous menu.



User Setting

You can configure the settings regarding user management and user and group permissions.

Management

You can add a user account(s) that can be edited at a later time.

1. From <SYSTEM SETUP> - <USER>, select <MANAGEMENT>.
2. Use the [▲▼◀▶/ENTER] buttons on the remote control or use the mouse to add a user account or select an item that you want to edit.
3. To apply the change, click <APPLY> in the bottom of the screen.
4. When done, press the [EXIT] button on the remote control or click <CLOSE> in the lower screen to return to the previous menu.



To add a user account

1. Click <ADD> in the bottom of the screen.
2. Use the [▲▼◀▶] buttons on the remote control and move to a desired item. Then, press [ENTER] to select the item.
 - USER ID : enter the user ID using the virtual keyboard.
 - PASSWORD : With the virtual keyboard, enter the password.
 - GROUP : From <ADMIN>, <MANAGER> and <USER>, select a group that the user belongs to.
 - EMAIL : Type in the e-mail address to which you will receive notification of an event if it occurs.
 - EMAIL NOTIFY : Choose whether you will receive notification of an event if it occurs.
 - COVERT CHANNEL : You can set the channel to hide from a specific user.
3. When done, click <OK>. The added user account will be listed.



System Setting

To edit the user account information

- From the list of users, select a user account to edit and click **<EDIT>** next to it.
- From the Edit window, make necessary changes and click **<OK>**.
- To delete the user account, click **<DELETE>**.
 ✓ The **<ADMIN>** account can not be changed or edited.



Group Authority

You can grant different user groups different permissions to a specific menu.

- From **<SYSTEM SETUP>** - **<USER>**, select **<GROUP AUTHORITY>**.
- Use the [**▲▼◀▶/ENTER**] buttons or use the mouse to set the permissions for both **<MANAGER>** and **<USER>** groups.
 - **SEARCH** : Set the permissions for the Search menu.
 - **ARCHIVING** : Set the permissions for the Backup menu.
 - **SYSTEM SETUP** : Set the permissions for the System Setup menu.
 - **RECORD SETUP** : Set the Access Permissions for the Record Setup menu.
 - **EVENT ACTION CONTROL** : Set the permissions to output the alarm or control the buzzer if an event such as alarm occurs.
 - **LISTEN TO AUDIO** : Set the permission to listen to the audio.
 - **MICROPHONE** : Set the permission to speak through the microphone.
 - **REMOTE LOG IN** : Set the permission to access remotely.
 - **SHUTDOWN** : Set the permission to shut down NVR from the System menu.
- To apply the change, click **<APPLY>** in the bottom of the screen.
- When done, press the **[EXIT]** button on the remote control or click **<CLOSE>** in the lower screen to return to the previous menu.



Network Setup

Specify the IP address, DDNS, e-mail, network status and network security.

IP Setup

Specify the IP address as well as the remote service port.

- From <SYSTEM SETUP> - <NETWORK>, select <IP SETUP>.
- Use the [▲▼◀▶/ENTER] buttons on the remote control or use the mouse to specify each item of the network settings.



- DHCP : If it is checked, set the IP address of the NVR to Dynamic IP.
 - If the <DHCP> item is checked, the sub items of IP address, gateway, subnet mask, primary DNS server, secondary DNS server will be filled in automatically.

! If you select to obtain an IP address from the <DHCP> server, when the lease time of the DHCP server expires, you will lose connection to the IP camera momentarily while the network settings will be updated. However, the network connection will be restored soon. It is recommended to use a fixed IP for stable network connection.

- RENEW : The network server restarts and re-allocates dynamic IP address.
 - IP ADDRESS : Provide the IP address.
 - GATEWAY : provide the gateway address.
 - SUBNET MASK : provide the subnet mask address.
 - 1ST DNS SERVER : enter the address of the primary DNS server.
 - 2ST DNS SERVER : enter the address of the primary DNS server.
 - AUTO PORT UPDATE : Regularly updates the selected WEB and RTSP ports of the router through UPnP function.
 - AUTO PORT STATUS : You can check AUTO PORT FORWARDING setup is properly configured.
 - RTSP SERVICE PORT : port number that the remote client receives the NVR video from.
 - WEB SERVICE PORT : port number used for connecting to the NVR with the web browser.
 - AUTO PORT FORWARDING : If you are using a router, you can set the port forwarding so that external access to the NVR is enabled.
If the router does not support the uPnP protocol, you must set the port forwarding manually.
For more information, contact your network administrator.
 - DELETE PORT : release the port forwarding settings for the router.
 - MAX TX SPEED : limit the network transfer rate to access a remote client.
The video signal may be transferred at a less rate than specified, which depends on the status of your network connection.
- To apply the change, click <APPLY> in the bottom of the screen.
 - When done, press the [EXIT] button on the remote control or click <CLOSE> in the lower screen to return to the previous menu.

System Setting

DDNS

You can configure the DDNS settings so that remote users who are connected to the network can access remotely.

- ✓ DDNS is an IP redirection service in a dynamic IP environment that redirects (maps) the new IP address to a registered domain name each time the IP address is changed.

1. From <SYSTEM SETUP> - <NETWORK>, select <DDNS>.

2. Use the [▲▼◀▶/ENTER] buttons on the remote control or use the mouse to specify the use of DDNS and select a server.

- DDNS : Specify the use of DDNS connection.
- DDNS SERVER : Select a server to connect to.
- NVR NAME : Enter the name of the NVR that you want to use as DDNS.
- DDNS REGISTRATION TEST : Check if the <NVR NAME> can be set as DDNS. If there is a duplicate name in the server, the registration will fail. If this is the case, rename the <NVR NAME> and press Test to check if it works properly.
- USER NAME : Use this field only if you set DDNS server to dyndns.org.
- PASSWORD : Use this field only if you set DDNS server to dyndns.org.
- NVR ADDRESS : Provide the <NVR NAME> and press the <DDNS REGISTRATION TEST> button. The name will be added automatically.
- DDNS CONNECTION TEST : Perform the connection test to check if DDNS is normally registered.

3. To apply the change, click <APPLY> in the bottom of the screen.

4. When done, press the [EXIT] button on the remote control or click <CLOSE> in the lower screen to return to the previous menu.



Email

You can register and test an email address so that an email notification is delivered at a specific interval or if an event occurs.

1. From <SYSTEM SETUP> - <NETWORK>, select <EMAIL>.

2. Use the [▲▼◀▶/ENTER] buttons on the remote control or use the mouse to specify the use of email and select a server.

- SERVER : Set up the mail server.
Set the mail server that will be used for notification to the NVR.
Use the virtual keyboard to enter your mail server.
- PORT : Enter the mail server port.
- SECURITY : If it is set to <On>, the email will be transferred in secure mode.
If it is set to <Off>, the email will be transferred to a server that does not support SSL.



- › USER : Provide the email account (ID) of the sender.
 - › PASSWORD : Provide the password of the sender.
 - › TEST EMAIL ADDRESS : Enter an email address for the test purpose.
 - › TEST : Send a test email and check if the test email is delivered normally.
3. To apply the change, click <APPLY> in the bottom of the screen.
 4. When done, press the [EXIT] button on the remote control or click <CLOSE> in the lower screen to return to the previous menu.

Network Status

From the network map screen, you can check the internet connection status and IP camera connection status, and check also the details of the connection status for each camera.

1. From <SYSTEM SETUP> - <NETWORK>, select <NETWORK STATUS>.
2. Use the [▲▼◀▶/ENTER] buttons on the remote control or use the mouse to select one between <NETWORK MAP> and <DETAIL STATUS>.
3. When done, press the [EXIT] button on the remote control or click <CLOSE> in the lower screen to return to the previous menu.

Network Map

- › IP ADDRESS : Indicates the internal IP address of the NVR.
- › MAC ADDRESS : Indicates the internal MAC address of the NVR.
- › DDNS ADDRESS : Indicates the internal DDNS address of the NVR.
- › RTSP SERVICE PORT : Indicates the network port of the video service.
For remote service, the router must have set up the port forwarding.
- › WEB SERVICE PORT : Indicates the web service network port.
For the remote service to be enabled, the corresponding port of the router should have set up the port forwarding.
- › DDNS UPDATE STATUS : Shows if the DDNS address was registered to the DDNS server normally. Press <C> to try to register the DDNS address forcibly.

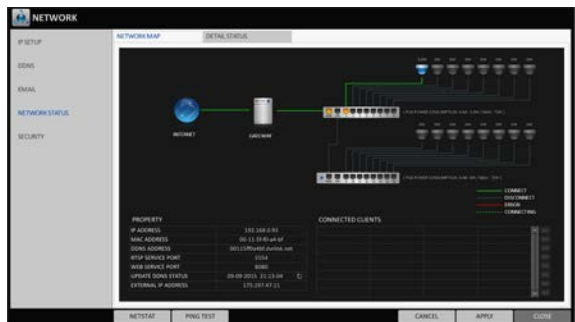

System Setting

- **EXTERNAL IP ADDRESS** : Indicate the IP address for the Internet, accessible from the NVR.
The NVR can be granted access with the web browser at "**http://<External IP Address>:<Web Service Port>**". The IP address can vary in a dynamic IP environment.
- **CONNECTED CLIENTS** : Shows the list of clients that are currently connected.
Press <■> to terminate the connection of an unwanted client forcibly.
- ✓ Termination is limited to only users in a lower group than the current user.
- ❗ The current PoE power consumption is updated sequentially in the order of channel.
- ❗ Alarm is generated if power consumption reaches 90% of rated supply capacity, for both NVR main unit and external PoE Hub.
This alarm threshold setting can be edited in "**EVENT > SYSTEM EVENT > POE FAIL EVENT**". (page 75)
- ❗ In OPEN mode, the POE power consumption is not displayed by camera.

Detail Status

You can check the details of the cameras that are connected to each channel.

Click <ⓘ> in the right area of the list to show the details.

Click <RESET> in the "**IP CAMERA CONFIGURATION**" window to reset the IP camera.

When the IP camera settings are complete, click <OK>.



Security

For security purpose, you can set whether to use encryption and its method, and configure IP filtering.

1. From <SYSTEM SETUP> - <NETWORK>, select <SECURITY>.
2. Use the [▲▼◀▶/ENTER] buttons on the remote control or use the mouse to select one between <ENCRYPTION> and <IP FILTER>.
3. When done, press the [EXIT] button on the remote control or click <CLOSE> in the lower screen to return to the previous menu.

ENCRYPTION

- RTSP ENCRYPTION ENABLE : Set whether to apply RTSP encryption or not.
- RTSP ENCRYPTION METHOD : Select the encryption method.
- HTTPS ENABLE : Set whether to use HTTPS encryption or not.
- HTTP AUTHENTICATION METHOD : Select the authentication method for encrypted communication.



IP FILTER

- IP FILTER ENABLE : Set whether to apply IP filter or not.
- IP FILTER RULE : You can set to allow or deny IP addresses listed in the IP filter.
- ADD : Click the button to add an IP address to be filtered, if IP filtering is enabled.



System Setting

System Setting

You can configure the settings of date/time, system management, system information, control device, POS/ATM and security.

Date/Time

Specify the current date and time.

- From <SYSTEM SETUP> - <SYSTEM>, select <DATE/TIME>.
- Use the [▲▼◀▶/ENTER] buttons on the remote control or use the mouse to change the time or set the options as necessary.
 - DATE/TIME : Set the current time and date. Click <🕒> to adjust the time manually.
 - DATE FORMAT : specify the date format.
 - TIME FORMAT : specify the time format.
 - TIME SERVER : obtain the current time from the time server. Click <🌐> to get the current time.
 - AUTO TIME SYNC : automatically synchronize the time with the time server at a specific time.
 - SYNC AT : Set the time to sync with the time server.
 - TIMEZONE : specify the GMT standard time for your local area.
 - DST : You can set up or release the DST (Daylight Saving Time).
- To apply the change, click <APPLY> in the bottom of the screen.
- When done, press the [EXIT] button on the remote control or click <CLOSE> in the lower screen to return to the previous menu.



System Management

You can check, update or reset the system information.

1. From <SYSTEM SETUP> - <SYSTEM>, select <SYSTEM MANAGEMENT>.
2. Use the [▲▼◀▶/ENTER] buttons on the remote control or use the mouse to set each option of the system management.



- FW UPDATE(NVR) : You can upgrade the current NVR software version.
- FW UPDATE(IP CAM) : You can upgrade the current IP CAM software version.
- FACTORY DEFAULT : Return the NVR settings to the factory default.
- SYSTEM DATA : Save the system settings or get the system information from other device.
 - SAVE : Store the NVR settings to a storage device. Connect the storage device to the USB port of NVR.



- LOAD : Apply the settings of the storage device to the NVR. Connect the storage device to the USB port of NVR.



System Setting

- NVR SELF-DIAGNOSIS : Checks out camera power, camera network, HDD and network port forwarding setup of the NVR. (CCTV only)

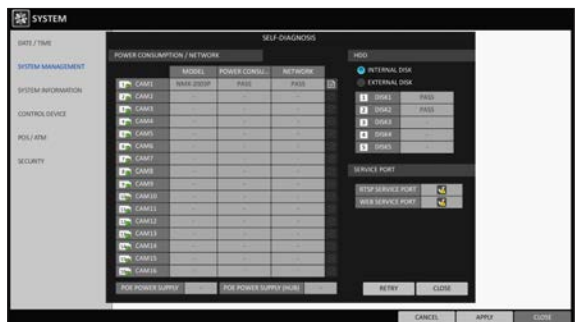

- NETWORK SETUP WIZARD : Triggered when the corresponding button is pressed or upon factory initialization. The wizard guides through network configuration such as setting the DHCP or static IP address, WEB and RTSP service ports.



- SYSTEM ID : Assign an ID to the NVR to distinguish it out from others when there are multiple NVR used.
 - PASSWORD : Open or close the dialog box for settings of the menus: quit, system settings, record settings, backup, and search.
 - ❗ If it is set to <OFF>, note that the ADMIN account is only effective and access to all menus will be restricted.
 - EXPIRED TERM OF PASSWORD : You will be prompted to change the current password after a certain period of time.
 - AUTO LOGOUT : If there is no user input for a certain period of time, you can set to log out automatically.
 - WAIT TIME : Specify the waiting time for Auto Logout.
 - PoE POWER LIMIT : Set the rated input power for PoE adaptor.
 - POE POWER LIMIT(HUB) : Set the rated input power for PoE adaptor (HUB).
 - AC POWER FREQUENCY : Set to the actual AC power's frequency (50Hz / 60Hz) applied to NVR to avoid flickering.
3. When done, press the **[EXIT]** button on the remote control or click <CLOSE> in the lower screen to return to the previous menu.

System Setting

To perform the upgrade

1. Connect the USB storage device that contains the updatable files.
2. Click <USB>.
3. Select one(s) from the updatable files listed in <F/W LIST>.
 - ✓ Firmware should be located in the <root> directory of the USB storage device. Do not place it under a certain folder.
 - ✓ To upgrade the connected IP CAM, select the channel connected to the camera to upgrade.
4. Click <UPGRADE>.
5. When the confirmation message appears, click <OK>.
6. The progress bar displays the progress of the firmware upgrade process.
7. When the upgrade is complete, reboot the system.
 - ! During the updating, never turn off the NVR forcibly or disconnect the USB storage device to avoid serious damage to the product or data. If required, consult your nearest service center for professional assistance.



System Information

You can check the current system version and system-related settings.

1. From <SYSTEM SETUP> - <SYSTEM>, select <SYSTEM INFORMATION>.
2. Check the status of the current system.
3. When done, press the [EXIT] button on the remote control or click <CLOSE> in the lower screen to return to the previous menu.



Control Device

Configure the settings of the remote control and keyboard controller.

1. From <SYSTEM SETUP> - <SYSTEM>, select <CONTROL DEVICE>.
2. Use the [▲▼◀▶/ENTER] buttons on the remote control or use the mouse to set the connection options for the control device.
 - › SYSTEM ID : Set the ID of the NVR so that the keyboard controller can identify.
 - › PROTOCOL : Set up the protocol of the keyboard controller.
 - › BAUD RATE : Set the data transmission speed.
 - › REMOTE CONTROLLER ID : Set the ID of the remote control.
3. To apply the change, click <APPLY> in the bottom of the screen.
4. When done, press the [EXIT] button on the remote control or click <CLOSE> in the lower screen to return to the previous menu.



System Setting

POS/ATM

You can check the configuration of the POS/ATM device connected to NVR.

- From <SYSTEM SETUP> - <SYSTEM>, select <POS/ATM>.
- Use the [▲▼◀▶/ENTER] on your remote control or use the mouse to check the POS/ATM settings.
 - ▶ ACTION : Specify whether to activate the POS/ATM device or not.
 - ▶ TYPE : Display the type for each channel.
 - ▶ PORT : Display the port for each channel.
- Change the data for each required item, and then press the <OK> button.
- To apply the change, click <APPLY> in the bottom of the screen.
- When done, press the [EXIT] button on the remote control or click <CLOSE> in the lower screen to return to the previous menu.



To set the POS

- Press the <EDIT> button to change in each channel.
 - ▶ PORT : You can change the linked port by pressing the <EDIT> button on the right.
 - ✓ The USB to serial device is required to add a port.
 - ▶ PROTOCOL : GENERAL is designated for PROTOCOL by default.
 - ▶ BAUDRATE : Select the BAUD RATE between 2400~115200.
 - ▶ DATA BIT : You can select between 5 and 8 for DATA BIT.
 - ▶ CHARACTER SET : The ASCII CHARACTER SET is designated by default.
 - ▶ PARITY : You can select NONE, ODD or EVEN for PARITY BIT.
 - ▶ STOP BIT : You can select 1 or 2 for STOP BIT.
 - ▶ TRANSACTION START : Enter the value for TRANSACTION START by using the virtual keyboard.
 - ▶ TRANSACTION END : Enter the value for TRANSACTION END by using the virtual keyboard.
 - ▶ LINE DELIMITER : Enter the value for LINE DELIMITER by using the virtual keyboard.
 - ▶ IGNORE STRING : Enter the string to ignore by using the virtual keyboard.
 - ▶ COPY SETTINGS TO : You can copy the settings to each channel.
 - ▶ TEST : You can test the settings through the POS.
- Complete editing and click <OK> to close the edit window.



Security

For security, you can set to apply reinforced password policy (to system, search/backup) and control accessing audio and snapshot.

1. From <SYSTEM SETUP> - <SYSTEM>, select <SECURITY>.
2. Use the [▲▼◀▶/ENTER] buttons on the remote control or use the mouse to set each option of security.

- **AUDIO SUPPORT** : Allows audio function.
If set to <OFF>, all audio functions are disabled. Live and playback screen do not produce audio, and no audio recording is allowed.

! Note that changing the setting from <OFF> to <ON> initializes audio related settings. Hence, reconfiguration is required after enabling.

- **SNAPSHOT SUPPORT** : Allows snapshot function.
If set to <OFF>, all capturing functions are disabled. User cannot take a snapshot on the Live screen, playback screen, and backup player screen.
Event notification with e-mail will not include event snapshot too.

! Note that changing the setting from <OFF> to <ON> initializes snapshot related settings. Hence, reconfiguration is required after enabling.

- **ENHANCED PASSWORD RULE** : Sets whether to apply strong password policy, which prevents using too easy password.
- **PASSWORD CHECK WHEN SEARCH/BACKUP** : Sets whether to ask password when attempted search/backup.
Set to <ON> to ask password when accessing backup menu. Using <EXPORT> on the timeline will ask password, too.

3. When done, press the [EXIT] button on the remote control or click <CLOSE> in the lower screen to return to the previous menu.



System Setting

Storage

You can configure the settings of and view information of the disk and external storage device.

Disk Information

It will show information about the connected disk.

- From <SYSTEM SETUP> - <STORAGE>, select <DISK INFORMATION>.
- Use the [▲▼◀▶/ENTER] buttons on the remote control or use the mouse to select either <INTERNAL DISKS> or <EXTERNAL STORAGE>. Please check the status for each connected device.
 - START / END TIME : show the start time and end time of data stored in each disk.
 - STATUS : check if the connected disk is being used by the NVR. If you encounter a problem with the disk, the NVR will terminate the connection to the disk and mark it as 'Not In Use'.
 - CAPACITY : show the capacity of the disk.
 - MODEL : indicate the disk model.
 - S.M.A.R.T STATUS : Read the S.M.A.R.T information of the disk and check to display if the current disk is in normal operation.
 - NORMAL : The disk is in a normal state.
 - CHECK : The disk has an error so that you need to check the disk or the connection cables of the disk. If you leave the problem unresolved, no recording may be enabled. So it is recommended that you replace the disk immediately.
 - ERROR : The disk fails or is unable to use due to an error of the disk or the cable. The disk should be replaced immediately. Contact the retailer or the customer service to replace the disk.
- When done, press the [EXIT] button on the remote control or click <CLOSE> in the lower screen to return to the previous menu.

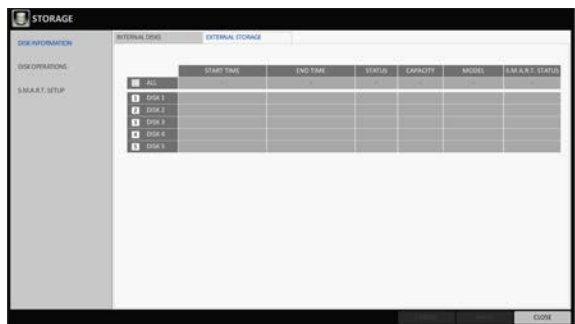

Disk Operations

You can set to delete the recording automatically and set the overwrite options, and you can also format the HDD recording data.

1. From <SYSTEM SETUP> - <STORAGE>, select <DISK OPERATIONS>.
2. Use the [▲▼◀▶/ENTER] buttons on the remote control or use the mouse to set the operation conditions of the disk.

› DISK WRITE MODE

- If it is set to <OVERWRITE>, the existing data will be overwritten by new recording data if the recording data size exceeds the free space of the HDD.
- If the option is set to <ONCE> and the HDD is full, the NVR will stop recording and output the beep or alarm that is pre-defined at <EVENT>.

› RECORDING TIME LIMIT : The recording data will be deleted after a specific time of reservation. Choose from <OFF>, <HOUR>, <DAY >, <WEEK>, you can limit the recording time. If it is set to <OFF>, this function will be disabled.

› DISK FORMAT : format the hard disk.

! Note that formatting the HDD will delete all video data and logs.

› ERASE VIDEO : You can delete all or part of stored video.
Click <ERASE> to move to "ERASE VIDEO" menu.
Set the beginning and ending time and click <ERASE> button to delete video of selected time range.

3. To apply the change, click <APPLY> in the bottom of the screen.

4. When done, press the [EXIT] button on the remote control or click <CLOSE> in the lower screen to return to the previous menu.

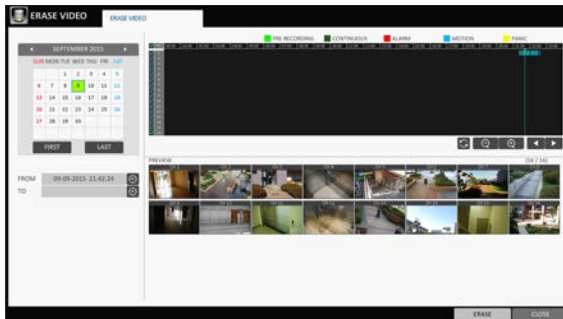

System Setting

S.M.A.R.T settings

You can check the S.M.A.R.T information of the disk and specify the check frequency.

✓ What is S.M.A.R.T information?

S.M.A.R.T (Self-Monitoring, Analysis and Report Technology) is to detect a HDD that is likely to cause a problem in the future with a warning message.

1. From <SYSTEM SETUP> - <STORAGE>, select <S.M.A.R.T. SETUP>.
2. Use the [▲▼◀▶/ENTER] buttons on the remote control or use the mouse to check the S.M.A.R.T operation and specify the check interval.

- ▶ S.M.A.R.T STATUS : Read the S.M.A.R.T information of the disk and check to display if the current disk is in normal operation. Click <DETAIL INFO> to view the details.
 - NORMAL : The disk is in a normal state.
 - CHECK : The disk has an error so that you need to check the disk or the connection cables of the disk. If you leave the problem unresolved, no recording may be enabled. So it is recommended that you replace the disk immediately.
 - ERROR : The disk fails or is unable to use due to an error of the disk or the cable. The disk should be replaced immediately. Contact the retailer or the customer service to replace the disk.
- ▶ S.M.A.R.T CHECK INTERVAL : Specify the S.M.A.R.T check interval. Click <CHECK NOW> to start checking.

3. To apply the change, click <APPLY> in the bottom of the screen.
4. When done, press the [EXIT] button on the remote control or click <CLOSE> in the lower screen to return to the previous menu.



Event Setup

Define various events, and specify the conditions to notify the user in various ways.

Alarm Out

Specify the alarm output conditions with the work schedule.

Alarm Out

- From <SYSTEM SETUP> - <EVENT>, select <ALARM OUT>.
- Use the [▲▼◀▶/ENTER] buttons on the remote control or use the mouse to select <ALARM OUT> and configure the related settings.

- NAME : You can rename the alarm.
- OPERATION : Set the alarm output mode.
 - N/O (Normal Open) : It normally stays Open. However, if an event occurs, it will switch to Close.
 - N/C (Normal Close) : It normally stays Close. However, if an event occurs, it will switch to Open.
- DURATION : Specify the duration of the alarm output.
 - TRANSPARENT : Keep the alarm out for as much time as the event lasts.
 - UNTIL KEY : Keep the alarm out until a mouse or remote control button is pressed.
 - 5 ~ 300 SEC : Keep the alarm out for as long as specified.
- TEST : Forcibly output the alarm for the test purpose.

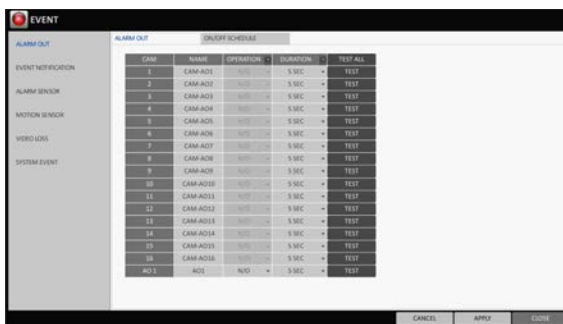

- To apply the change, click <APPLY> in the bottom of the screen.
- When done, press the [EXIT] button on the remote control or click <CLOSE> in the lower screen to return to the previous menu.

System Setting

ON/OFF Schedule

You can activate or turn off the alarm output as scheduled.

1. Use the [**▲▼◀▶**]/**ENTER** buttons on the remote control or use the mouse to select a <DATE> for the schedule.
2. Drag the mouse to resize the cell or use the on the [**▲▼◀▶**] buttons to move to the cell, then press **ENTER**.
3. Select a desired alarm output mode.
 - ON : The alarm output is always turned on.
 - OFF : The alarm output is always turned off.
 - EVENT : Trigger the alarm output in sync with the event.
4. Click <COPY SCHEDULE TO> to check the checkbox of the date that you want to copy the schedule at.
5. When done, click <OK> to apply the settings.
6. To apply the change, click <APPLY> in the bottom of the screen.
7. When done, press the **EXIT** button on the remote control or click <CLOSE> in the lower screen to return to the previous menu.

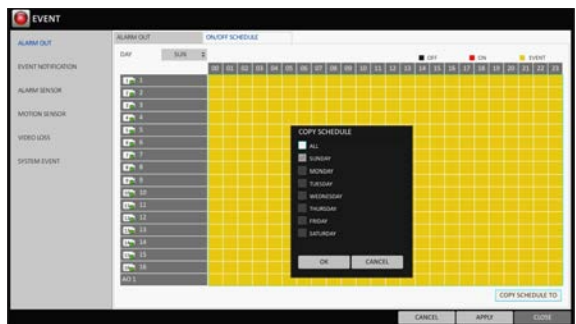
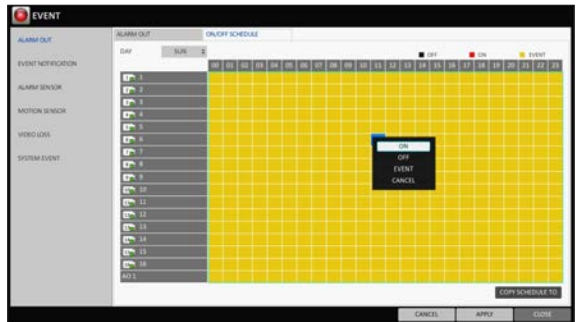

Event Notification

Specify the methods of notification such as buzzer, video popup, email or FTP if an event occurs.

1. From <SYSTEM SETUP> - <EVENT>, select <EVENT NOTIFICATION>.
2. Use the [**▲▼◀▶**] buttons on the remote control or use the mouse to select one from <BUZZER>, <DISPLAY>, <EMAIL> and <FTP>.
3. Use the [**▲▼◀▶**]/**ENTER** buttons on the remote control or use the mouse to set the output method and duration.
4. To apply the change, click <APPLY> in the bottom of the screen.
5. When done, press the **EXIT** button on the remote control or click <CLOSE> in the lower screen to return to the previous menu.

Buzzer output

You can notify the user of the event using the buzzer.

› DURATION

- TRANSPARENT : Keep the buzzer out for as much time as the event lasts.
- UNTIL KEY : Keep the buzzer out until a mouse or remote control button is pressed.
- 5 ~ 300 SEC : Keep the buzzer out for as long as specified.



Display

If an event occurs, you can display the video screen or a popup message to notify the user of the event.

› VIDEO POPUP : Display the video channel that is synchronized with the event on a single split screen. Set the DURATION of the single split screen.

- UNTIL KEY : Keep the video popup displayed until a mouse or remote control button is pressed.
- 5 ~ 300 SEC : Keep the video popup displayed for as long as specified.

- ✓ If multiple events occur at the same time, or if multiple event-related video channels exist, the video popup will be displayed in the maximum split screen mode rather than the single split screen mode.

› OSD POPUP : This will notify the user of the event with a popup message if an OSD popup event occurs. You can adjust the duration of the popup message.

- UNTIL KEY : Keep the OSD popup displayed until a mouse or remote control button is pressed.
- 5 ~ 300 SEC : Keep the OSD popup displayed for as long as specified.



System Setting

Email

If an event occurs, this will notify registered users of the event by email. If you do not want to receive the email, uncheck the <EMAIL NOTIFY> option in <MANAGEMENT>. (Page 49)

- **ADD NEW EMAIL** : If you want to add a new mail recipient beside the existing ones, click <EDIT> to add the recipient.
- **MINIMUM EMAIL FREQUENCY** : Adjust the minimum frequency of sending the email.
For example, even if you have set the minimum frequency to one minute and another event occurs in less than one minute after the last email sending, the email for the new event will be sent one minute after.
- ✓ Some email servers can block the email sending if the email delivery cycle is too short, and classify it as spam.
Contact your email service provider to adjust the minimum delivery cycle so that the server does not classify the email as spam.



- **INCLUDE SNAPSHOT IMAGE** : Set whether to include snapshot image of the event with the notification.

FTP

Upon events, uploads event notification onto the added FTP server.

- **FTP SERVER** : Enter the FTP server address for event transfer.
- **DIRECTORY** : Select or manually enter the destination folder of the FTP for event transfer.
- **FILE NAME** : Select the uploading event file's format or manually set the file name.
- **MINIMUM FREQUENCY** : Sets the minimum recurrence delay for uploading event notification onto the FTP server.
For example, when the minimum recurrence is set to 1 minute, the next FTP event notification will be uploaded after 1 minute from the last event, even if another event is detected within 1 minute from the last one.
- **INCLUDE WEBRA LINK** : Select whether to include WEBRA link address of the event generating NVR, which can be accessed with web browser (Internet Explorer).
- ✓ Check to play back the event footage.
- **INCLUDE SNAPSHOT IMAGE** : Set whether to include snapshot (still image) or not.



Alarm Sensor

You can configure the settings of the alarm sensor and specify the operation of the sensor if an event occurs.

1. From <SYSTEM SETUP> - <EVENT>, select <ALARM SENSOR>.

2. Use the [▲▼◀▶] buttons on the remote control or use the mouse to specify the sensor input method and operation.

- NAME : You can specify the name of the alarm sensor.
- OPERATION : You can specify the type of the alarm sensor.
 - N/O (Normal Open) : Normally the sensor is left Open. If the sensor switches to Close, an event will be triggered.
 - N/C (Normal Close) : Normally the sensor is left Close. If the sensor switches to Open, an event will be triggered.



- LINKED CAMERA : Set the camera to sync with the alarm sensor if it is triggered. If you have set the alarm recording and the sensor detects the recording, all synchronized cameras will start alarm recording.
- ALARM OUTPUT : Specify the alarm output channel if it is detected by the alarm sensor. The alarm will be output to the specified channel.
- PRESET : On alarm sensor's detections, the camera moves as defined by the selected preset.
- BUZZER : Specify the output of the buzzer if an alarm is detected by the alarm sensor.
- VIDEO POPUP : Select to display the video popup if an alarm is detected by the alarm sensor. If there exist multiple <LINKED CAMERA>, the video popup will be displayed in the maximum split mode.
- OSD POPUP : Select to display the OSD popup message if it is detected by the alarm sensor.
- EMAIL : Select to send an email if detected by the alarm sensor.
- FTP : Select whether to upload event notification onto the FTP upon detected alarm event.

3. To apply the change, click <APPLY> in the bottom of the screen.

4. When done, press the [EXIT] button on the remote control or click <CLOSE> in the lower screen to return to the previous menu.

System Setting

Motion Sensor

You can set an action to execute when a motion is detected.
For the settings of the motion sensor, move to <CAMERA SETUP>.

- From <SYSTEM SETUP> - <EVENT>, select <MOTION SENSOR>.
- Use the [▲▼◀▶] buttons on the remote control or use the mouse to specify the ignorance interval and operation.
 - **IGNORING INTERVAL** : Specify the minimum interval of the motion event occurrence.
For example, even if you have set the minimum frequency to 5 seconds and another motion event occurs in less than 5 seconds after the last motion event occurred, the new event will be ignored. If too many motion events occur, adjust to shorten the interval.

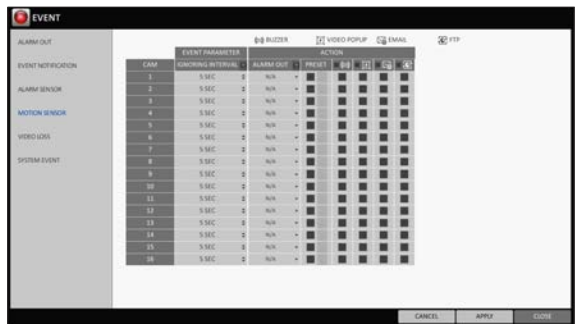

- ✓ Motion recording will be triggered immediately after the motion occurred regardless of the above settings.
 - **ALARM OUTPUT** : Specify the alarm output channel if a motion is detected by the motion sensor.
 - **PRESET** : On motion sensor's detections, the camera moves as defined by the selected preset.
 - **BUZZER** : Specify the output of the buzzer if a motion is detected by the motion sensor.
 - **VIDEO POPUP** : Select to display the video popup if a motion is detected by the motion sensor.
 - **EMAIL** : Select to send an email if a motion is detected by the motion sensor.
 - **FTP** : Select whether to upload event notification onto the FTP upon detected motion event.
- To apply the change, click <APPLY> in the bottom of the screen.
 - When done, press the [EXIT] button on the remote control or click <CLOSE> in the lower screen to return to the previous menu.

Video Loss

You can specify a reaction to the case where no video is received from the camera.

1. From <SYSTEM SETUP> - <EVENT>, select <VIDEO LOSS>.
2. Use the [▲▼◀▶] buttons on the remote control or use the mouse to specify the reaction to a video loss.
 - ALARM OUTPUT : Specify the alarm output channel if a video loss occurs.
 - PRESET : On video loss's detections, the camera moves as defined by the selected preset.
 - BUZZER : Specify the output of the buzzer if a video loss occurs.
 - EMAIL : Select to send an email if a video loss occurs.
 - FTP : Select whether to upload event notification onto the FTP upon detected video loss event.
3. To apply the change, click <APPLY> in the bottom of the screen.
4. When done, press the [EXIT] button on the remote control or click <CLOSE> in the lower screen to return to the previous menu.



System Setting

System Event

You can set event actions for disk, recording, network and system events. As same to setting event actions for normal events, you can set to trigger alarm output, buzzer, display on-screen pop-up, or send event notification via email and FTP.

1. From <SYSTEM SETUP> - <EVENT>, select <SYSTEM EVENT>.
2. Use the [▲▼◀▶] buttons on the remote control or use the mouse to specify the reaction to each event.
3. To apply the change, click <APPLY> in the bottom of the screen.
4. When done, press the [EXIT] button on the remote control or click <CLOSE> in the lower screen to return to the previous menu.

Disk

- › OVERWRITE START EVENT : if you set the disk write mode to <OVERWRITE>, this event occurs when the disk is full and the overwriting begins accordingly.
- › DISK FULL EVENT : if you set the disk write mode to <ONCE>, this event occurs when the disk is full (100%).
- › DISK SPACE EXHAUSTED EVENT : Event that is triggered if the disk is almost full. Click to specify the threshold percentage of usage to trigger the event.
- › S.M.A.R.T EVENT : Occurs if the disk causes the S.M.A.R.T error.
- › NO DISK EVENT : Occurs if no disk is recognized after the booting due to a disk failure or cable problem.

! To detect the disk error, it is recommended not to change the settings of the S.M.A.R.T event, no disk event and buzzer output.



Record

- › PANIC RECORD START EVENT : Specify the action to perform when the panic recording begins.



System

- **BOOTING EVENT:** This event occurs when the NVR is booting.
- **LOGIN FAIL EVENT:** This event occurs when the NVR fails to log in.
You can specify the times of clicking <  > to trigger the event.
- **FAN FAIL EVENT :** This event occurs if the CPU cooling fan or unit's cooling fan does not work at all.
- ✔ If the fan fails, no recording will proceed by the NVR. If you encounter a fan failure, contact the retailer or the service center for technical assistance.



- **TEMPERATURE FAIL EVENT :** This event occurs if the internal temperature of the NVR exceeds the effective range. Then, the NVR will not operate normally. If this is the case, check the followings and take a necessary measure.
 - Check if the ventilation of the NVR is clogged with foreign substances. If so, remove them.
 - Keep the NVR away from a heat source such as heater. Install it in a flat, lower area with good ventilation.
 - If the problem persists, contact the retailer or service center.
- **POE FAIL EVENT :** This event occurs if power consumption reaches specified level of power supply capacity of NVR and external PoE Hub.
- ❗ To monitor the normal operation of the NVR, it is recommended not to change the buzzer output settings of the fan failure event and the temperature fail event.

Network

- **TROUBLE IN INTERNET CONNECTION :** Occurs if the Internet connection to the NVR fails.
If you do not want to connect the NVR to the network, leave the <**ACTION**> item blank.
- **FAIL IN REMOTE LOGIN :** This event occurs if a remote client fails to log in due to an invalid ID or password.
You can specify the times of clicking <  > to trigger the event.
- **FAIL IN DDNS UPDATE :** This event occurs if the NVR tried to update the DDNS address but failed.
- ✔ If the DDNS address fails to be updated, the NVR may not connect to a remote client. If this is the case, enter the IP address from the client side to allow access from the NVR. This is just a temporary measure.
For the IP address, move to and check <**EXTERNAL IP ADDRESS**> from the <**NETWORK**> window. Note that the <**EXTERNAL IP ADDRESS**> is subject to change if the NVR does not use the static IP. (page 54)
- ❗ Note that the <**EXTERNAL IP ADDRESS**> can change at any time in a dynamic IP environment.



Record Setting

You can configure the record settings for the NVR. Only authorized users can access the Record Setup menu.

To start the Record Setup menu

How to use the mouse

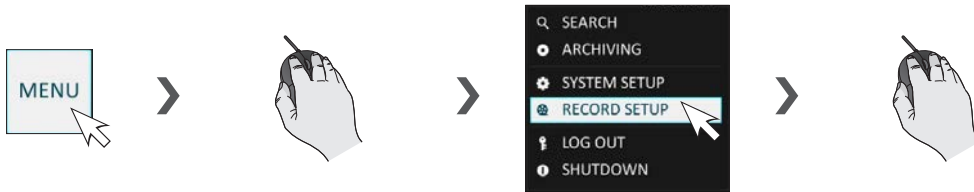

How to use the remote control

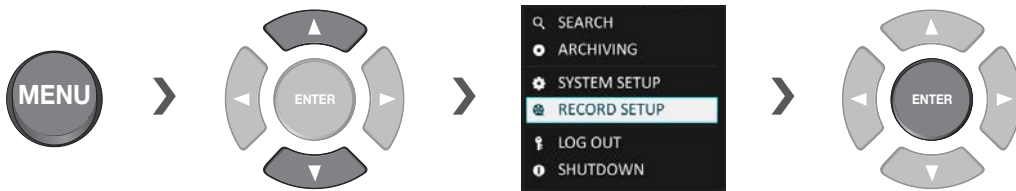

You can configure the record settings for the NVR. Only authorized users can access the Record Setup menu.

Record Setup

Operation Mode

You can set the recording options for Auto or Manual mode.

1. From <RECORD SETUP> menu, select <OPERATION MODE>.
2. Use the [▲▼◀▶] buttons or use the mouse to set <RECORDING CONFIGURATION MODE> to <AUTO CONFIGURATION> or <MANUAL CONFIGURATION>.
3. Set the recording options for each selected Record mode.
4. To apply the change, click <APPLY> in the bottom of the screen.
5. When done, press the [EXIT] button on the remote control or click <CLOSE> in the lower screen to return to the previous menu.

Auto Configuration

If you choose your preferred record mode, the NVR will recommend you the optimized settings for the selected record mode.

- CONTINUOUS RECORD : Records always regardless of events.
 - LONG DURATION BUT LOW QUALITY : Recording will proceed in the low quality at all times. As this option will always make recording in the low quality, the recording period is the longest compared to the other record modes.
 - HIGH QUALITY BUT SHORT DURATION : Recording will proceed in the best quality at all times. As this option will always make recording in the best quality, the recording period is the shortest compared to the other record modes.
- MOTION RECORD : Recording will proceed only if a motion is detected.
- ALARM RECORD : Recording will proceed only if an alarm event occurs.
- MOTION/ALARM RECORD : Recording will proceed only if a motion is detected or an alarm event occurs.
- INTENSIVE MOTION RECORD : Normally recording will be performed in a low quality. However, the quality will switch to high if a motion is detected.
- INTENSIVE ALARM RECORD : Normally recording will be performed in a low quality. However, the quality will switch to high if an alarm event occurs.
- INTENSIVE MOTION/ALARM RECORD : Normally recording will be performed in a low quality. However, the quality will switch to high if an alarm event occurs or a motion is detected.



Record Setting

Manual Configuration

If you set the record mode to <MANUAL CONFIGURATION>, the manual configuration window will appear where you can set the manual recording and panic recording options.

- **MANUAL CONFIGURATION OPTIONS :** You can configure the recording settings by the time, date, and channel.
 - **SCHEDULE MODE :** You can schedule your recording with time range or combining time with selected week days.
 - **PRE RECORDING TIME :** Set the pre-recording time.
 - **POST RECORDING TIME :** Set the post-recording time.
- **PANIC RECORDING OPTIONS :** Set the panic recording duration. If it is set to <MANUAL>, recording will continue until you turn it off manually.



Continuous Recording

You can configure the settings of: continuous recording time, recording size, frame rate per second and quality.

1. From the <RECORD SETUP> menu, select <CONTINUOUS RECORDING>.
 - ✓ From <OPERATION MODE>, you must set <RECORDING CONFIGURATION MODE> to <MANUAL CONFIGURATION> before you can set the <CONTINUOUS RECORDING>.
2. Use the [▲▼◀▶] buttons on the remote control or use the mouse to select either <SIZE/FPS/QUALITY> or <SCHEDULE>.

Size/FPS/Quality Setting

1. Please select the day of the week to perform the continuous recording. To select <DAY>, set the <SCHEDULED MODE> to <WEEKLY> in <MANUAL CONFIGURATION OPTIONS> of <OPERATION MODE>.
2. Click a time cell from which you want to edit the SIZE/FPS/Quality and drag it to a desired cell. Or use the [▲▼◀▶] buttons on the remote control to move to the cell and press [ENTER]. Then, use the [▲▼◀▶] buttons to move to a desired cell and press [ENTER] again.

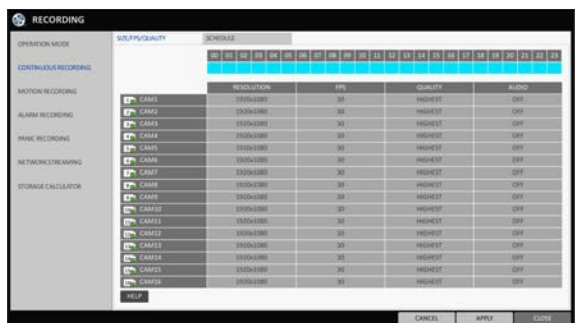

- When the cell selection is complete, the "SIZE/FPS/QUALITY" table appears.

! Specify the <RESOLUTION>, <FPS>, <QUALITY> and use of the <AUDIO> recording for each channel.

- RESOLUTION : set the size of the video recording.
- FPS : set the frame rate per second.
- QUALITY : set the recording quality.
- AUDIO : specify the use of the audio recording.
- HELP : You can view help text regarding the recording configuration.



- When done, click <OK>. You can check the recording size in the size table under the time recording bar.

! The video size, FPS, quality and audio recording options may differ depending on the specification of the IP camera. For some IP cameras, the video transfer may be interrupted if some of the options are changed.

Schedule Setting

- Select a start day of the week on the schedule.
- Click a time cell from which you want to make the schedule and drag it to a desired cell. Or use the [▲▼◀▶] buttons on the remote control to move to the cell and press [ENTER]. Then, use the [▲▼◀▶] buttons to move to a desired cell and press [ENTER] again.
- When the time selection is complete, you will be prompted to specify the use of recording in the Record Setup window.
- Click <COPY SCHEDULE TO> to check the checkbox of the date that you want to copy the schedule at.
- To apply the change, click <APPLY> in the bottom of the screen.
- When done, press the [EXIT] button on the remote control or click <CLOSE> in the lower screen to return to the previous menu.

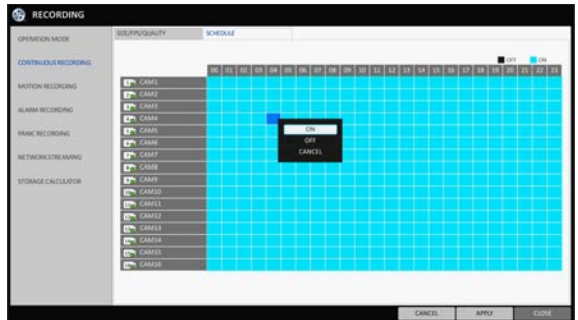

Record Setting

Motion Recording

Specify the recording size of the motion event if it occurs and make schedule for that recording.

- From the <RECORD SETUP> menu, select <MOTION RECORDING>.
 - From <OPERATION MODE>, you must set <RECORDING CONFIGURATION MODE> to <MANUAL CONFIGURATION> before you can set the <MOTION RECORDING>.
- Use the [▲▼◀▶] buttons on the remote control or use the mouse to select either <SIZE/FPS/QUALITY> or <SCHEDULE>.
- Set each item for the motion recording.
 - For more information, see the "Continuous Recording". (page 78)
- To apply the change, click <APPLY> in the bottom of the screen.
- When done, press the [EXIT] button on the remote control or click <CLOSE> in the lower screen to return to the previous menu.



Alarm Recording

Specify the recording size of the alarm event if it occurs and make schedule for that recording.

- From the <RECORD SETUP> menu, select <ALARM RECORDING>.
 - From <OPERATION MODE>, you must set <RECORDING CONFIGURATION MODE> to <MANUAL CONFIGURATION> before you can set the <ALARM RECORDING>.
- Use the [▲▼◀▶] buttons on the remote control or use the mouse to select either <SIZE/FPS/QUALITY> or <SCHEDULE>.
- Set each item for the alarm recording.
 - For more information, see the "Continuous Recording". (page 78)
- To apply the change, click <APPLY> in the bottom of the screen.
- When done, press the [EXIT] button on the remote control or click <CLOSE> in the lower screen to return to the previous menu.

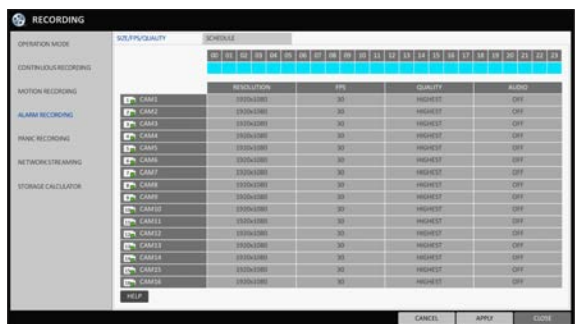

Panic Recording

In panic recording mode, you can specify the recording size and quality of the video.

1. From the <RECORD SETUP> menu, select <PANIC RECORDING>.
2. Set each item of <RESOLUTION>, <FPS>, <QUALITY> and use of the <AUDIO> for the panic recording.
 - ✓ For more information, see the "Continuous Recording". (page 78)
3. To apply the change, click <APPLY> in the bottom of the screen.
4. When done, press the [EXIT] button on the remote control or click <CLOSE> in the lower screen to return to the previous menu.



Network Streaming

You can specify the maximum size of network streaming for remote users and set the FPS.

- ✓ Even if you set the resolution and FPS to high for the network streaming, the NVR will reduce the size or FPS according to the network status (speed) before transferring the recording video.
1. From the <RECORD SETUP> menu, select <NETWORK STREAMING>.
 2. Use the [▲▼◀▶/ENTER] buttons on the remote control or use the mouse to select an item that you want to edit.
 3. Set the <MAX RESOLUTION> and <MAX FPS> for each channel.
 - ENABLE ADAPTIVE STREAMING CONTROL FOR REMOTE CLIENTS. : Optimizes the transfer rate for client PC and mobile accesses, in case the network connection (through the Internet) is low speed. (Default : Selected / Enabled)
 - ✓ Frame rate of recorded video playback may drop to 15 fps for recordings of 5 or more split screens.
 4. When done, click <OK>.
 5. To apply the change, click <APPLY> in the bottom of the screen.
 6. When done, press the [EXIT] button on the remote control or click <CLOSE> in the lower screen to return to the previous menu.



Record Setting

Storage Calculator

You can calculate and estimate the available recording time based on the installed HDD capacity and designated recording method.

1. From the <RECORD SETUP> menu, select <STORAGE CALCULATOR>.
2. Current saving mode is displayed according to the settings in OPERATION MODE.
 - AVERAGE MOTION EVENT RATIO PER HOUR : Set a value for average motion event ratio per hour between 0~100%.
 - AVERAGE ALARM EVENT RATIO PER HOUR : Set a value for average alarm event ratio per hour between 0~100%.
3. Click the <CALCULATE> to calculate the estimated time period that you can record based on current settings.



! All of the camras should be connected.

This test result may have a different actual recordig period from installation environment or connected camera model.

Search

You can search for the recording data in the HDD by the criteria of time, thumbnail, event, text-in, etc.

To move to the Search menu while in monitoring

How to use the mouse

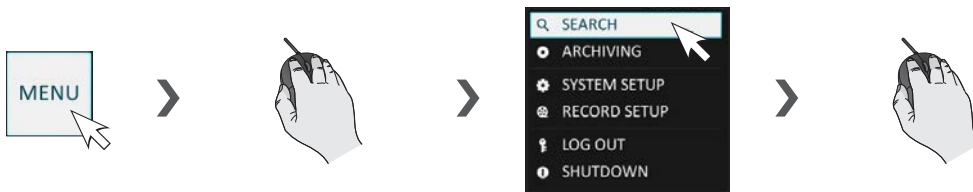

How to use the remote control 1

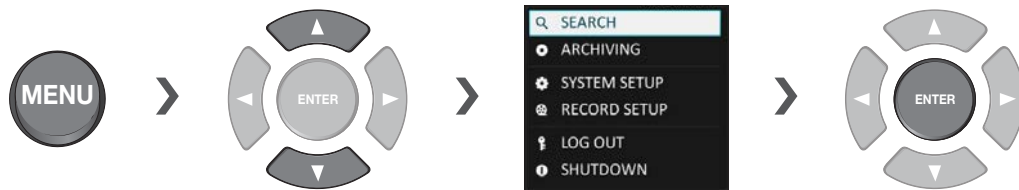

How to use the remote control 2



To move to the Search menu while in playback mode

How to use the mouse

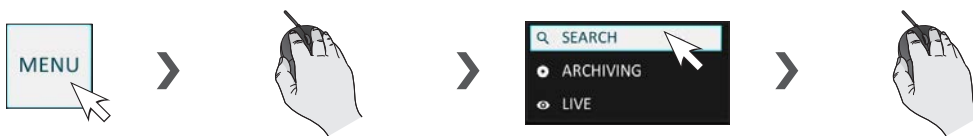

How to use the remote control



Search

Search

Search Settings

Time Search

With the calendar, you can search for the recording data by the recorded date.

- From the <SEARCH> menu, select <TIME SEARCH>.
- Use the [▲▼◀▶] buttons or use the mouse to specify the search date and time from the calendar in the left corner of the screen.
 - FIRST : The first date of recording is automatically selected.
 - LAST : The last date of recording is automatically selected.
 - 🕒 : Press this to display the time selection menu where you can specify the time and date.
- You can identify the type of the recording data by the color in the bar.
 - Yellow Green (Pre recording) : The pre-recording is performed on the recording data after you set the <PRE RECORDING TIME> from <OPERATION MODE>.
 - Green (Continuous) : The continuous recording is performed on the recording data.
 - Red (Alarm) : The alarm event recording is performed on the recording data.
 - Blue (Motion) : The motion event recording is performed on the recording data.
 - Yellow (Panic) : The panic manual recording is performed on the recording data.
- Click to move to a desired start time in the time bar, or use the buttons at the bottom of the status bar to make search.
 - 🔄 : Recall the recording data.
 - 🔍 : Expand the timeline of the time bar to a greater unit of time.
 - 🔍 : Collapse the timeline of the time bar to a smaller unit of time.
 - ⏪ : Use this to move to a previous time that is hidden in the time bar as it is expanded to a greater time unit.
 - ⏩ : Use this to move to a next time that is hidden in the time bar as it is expanded to a greater time unit.
- Click a thumbnail channel or use the [▲▼◀▶] buttons on the remote control to move to a desired channel and press [ENTER]. You can check the video in <PREVIEW>.
 - ❗ Click to move to a desired time, or simply double-click a desired time in the time bar to play the video data on that time.
- Press the [ENTER] button again on the remote control with the mouse, or simply double-click on the channel. You will move to the playback screen.
- If you want to stop playing and return to the search screen, press [EXIT] or [SEARCH] on the remote control. You can also click <MENU> in the lower left corner and select a desired menu.

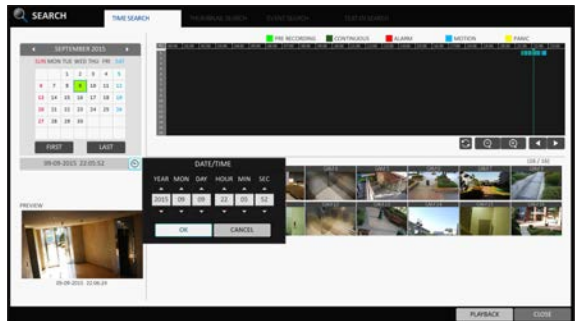
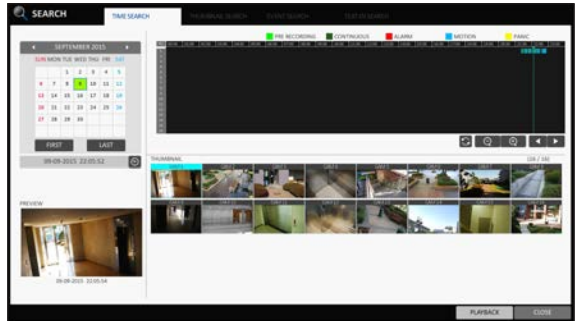

Thumbnail Search

To improve your search, you will be provided with a list of thumbnails. Select Day, Hour or Minute to narrow down the search results.

1. From the <SEARCH> menu, select <THUMBNAIL SEARCH>.
2. Use the [▲▼◀▶] buttons or use the mouse to specify the search date and time from the calendar in the left corner of the thumbnail search screen.
 - FIRST : The first date of recording is automatically selected.
 - LAST : The last date of recording is automatically selected.
 - CHANNEL : Select a channel to search for.
 - DATE/TIME : Specify the search date and time.
 - ✔ The menus available differ depending on the selected interval mode.
 - INTERVAL: Select a time interval of the thumbnail view.
3. Double-click a desired play time in the recording data bar, or double-click a desired time image from the thumbnail list. You will move to the playback screen.
4. If you want to stop playing and return to the search screen, press [EXIT] or [SEARCH] on the remote control. You can also click <MENU> in the lower left corner and select a desired menu.

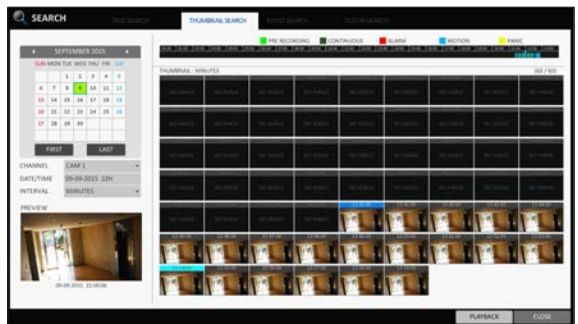

< "MINUTES" selection screen >

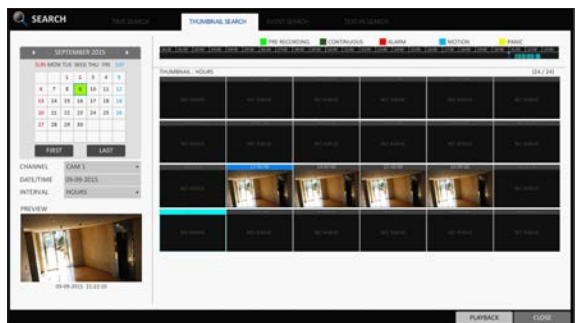

< "HOURS" selection screen >

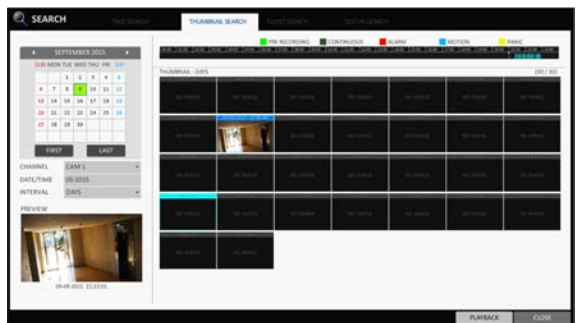

< "DAYS" selection screen >

Search

Event Search

Search for events that occurred at the specified time and select an event to play from the list.

1. From the <SEARCH> menu, select <EVENT SEARCH>.
2. Use the [▲▼◀▶] buttons or use the mouse to specify the <START> and <END> times in the left of the event search list.
3. Select a channel to search.
4. Mark the checkbox of the event to search from the <EVENT> list.
5. Press the <SEARCH> button.
The search results will be listed as shown.



- › TYPE : displays the event type.
 - › TIME : displays the recording start time.
 - › CONTENTS : shows the details of the event found.
 - › ORDER BY : If you select <OLDEST>, the list will be sorted with the earliest one on top.
6. Double-click a desired event or click <PLAYBACK> in the lower right corner to move to the play screen.
 7. If you want to stop playing and return to the search screen, press [EXIT] or [SEARCH] on the remote control.
You can also click <MENU> in the lower left corner and select a desired menu.

Text-in Search

You can search for the text generated at a predefined time and select the text from the list to playback.

1. From the <SEARCH> menu, select <TEXT-IN SEARCH>.
2. Use the [▲▼◀▶] buttons or use the mouse to specify the <FROM> and <TO> times in the left of the event search list.
3. Select the check box(es) for the channel(s) to search.
4. Enter the keyword in <ITEM KEYWORD> to search for.
 - MATCH CASE : Perform a case-sensitive search for the keyword entered.
 - MATCH WHOLE WORD ONLY : Perform an exact word search for the keyword entered.
5. Press the <SEARCH> button.
 - TIME : Recording Start Time is displayed.
 - CHANNEL : Selected channel is displayed.
 - ITEM : Detail keywords are displayed.
 - ORDER BY : Select the <LATEST> to display the keywords in sequence from the beginning in the list.
6. Double-click a desired event or click <PLAYBACK> in the lower right corner to move to the play screen.
7. If you want to stop playing and return to the search screen, press [EXIT] or [SEARCH] on the remote control. You can also click <MENU> in the lower left corner and select a desired menu.



Playback

If you want to play

1. To play the searched data
You can search for and play a searched data.
2. To play with the live viewer
 - Simply double-click a desired time point in the right corner of the play screen.
 - ✓ If you move the cursor to the rightmost, the "Timeline" bar will be displayed.
 - Select a desired channel in the live screen and right-click to select <Playback> in the context menu. Then, select a desired play time.

Playback screen configuration

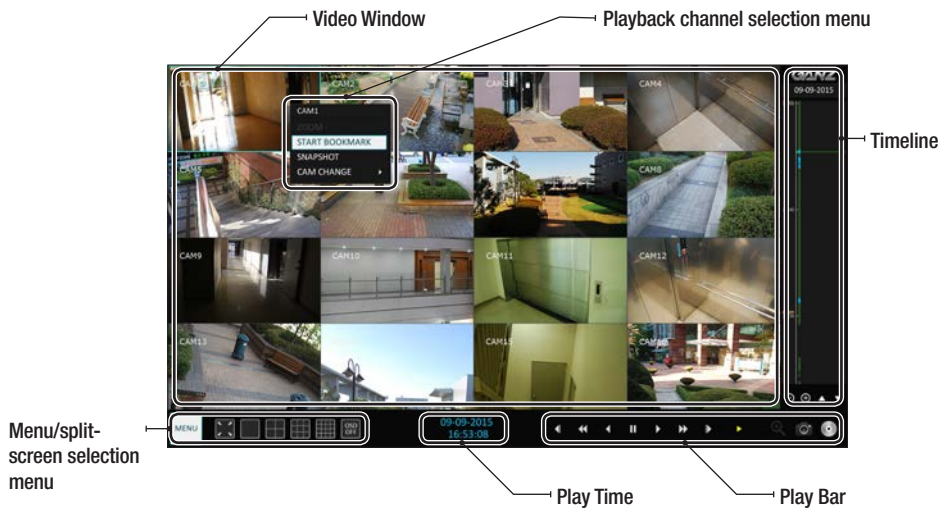

Video Window

Display the current video.

Timeline

Display the type of recording data.

The vertical bar in the timeline indicates the current point of playback. Double-click a desired point in the timeline to start playing the video from that point.

Once you drag to specify an area, you can perform the backup or event search for that area.

Menu/split-screen selection menu

For more information about how to use each button, refer to "Using the status bar in the live mode". (page 28)









Play Bar

You can start playing, stop playing or change the play speed of the current video.

Playback channel selection menu

Item	Description
CAM1	Display the title of the selected channel.
ZOOM	Zoom the video of the selected channel. (The zooming function is active only in '1' split screen.)
START BOOKMARKING	The "BOOKMARK SETUP" popup appears, and you can bookmark a play point for the backup purpose.
SNAPSHOT	Capture the current live video and save it in the .jpeg format.
CAM CHANGE	You can assign the selected screen to another channel.

Using the play bar

Item	Description
Jump	 Move forward or backward.
Reverse Fast Play	 The video will be reversely played at the speed of x64 > 32 > 16 > 8 > 4 > 2 in this order.
Reverse Play	 Play the video in the reverse direction.
Pause	 Stop playing forward or playback temporarily.
Play	 Play the video forward.
Fast Forward	 The video will be played forward at the speed of x2 < 4 < 8 < 16 < 32 < 64 in this order.
Zoom In	 Move to the zoom in/out screen of the selected channel.
Snapshot	 Capture the current live video and save it in the .jpeg format. Then, you can save the captured video in the HDD or export it to an external USB memory device. While you perform the snapshot, the current video will be stopped playing.
Start/end bookmark	 Add a bookmark for the current playback screen. Press this to display the "BOOKMARK SETUP" window. Provide each entry and click Start. The arrow in the bookmark button blinks to indicates that the bookmarking is in process. If you press the Bookmark button again, the bookmarking stops and the current settings will be reserved. Then, the reserved data can be backed up in Archive menu or can be played in the "RESERVED DATA MANAGEMENT" menu.

Playback

Bookmarking

During playback, you can add a bookmark for reserving the video data.

You can view the bookmarked data in the Archive menu, which can be saved to a connected device for the backup purpose.

1. Provide a tag in the <TAG> item for data reservation.
2. Provide the details of the reserved data in the <MEMO> input box.
3. Click <START>. You will return to the play screen with the backup progress.
4. To stop the bookmarking, click <BOOKMARK(📌)>.
5. To quit the bookmarking, click <STOP>. To continue with bookmarking, just click <CONTINUE>.
6. Click <RESERVE>. You can export the reserved data to a connected storage device using the <ARCHIVING> menu.

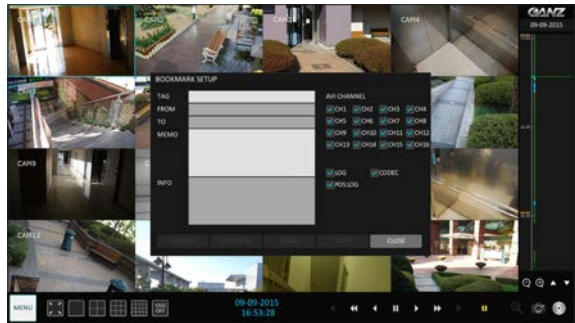

- ✓ What is the <RESERVE> function?
With the <RESERVE> function, you can reserve data even in overwrite mode.
This is useful if you want to backup data but you have no backup device available such as USB memory.
If you use "Reserve", the recording days will be compromised.
When you have backed up the reserved data to an external device, it is recommended to delete the internal reserved data.

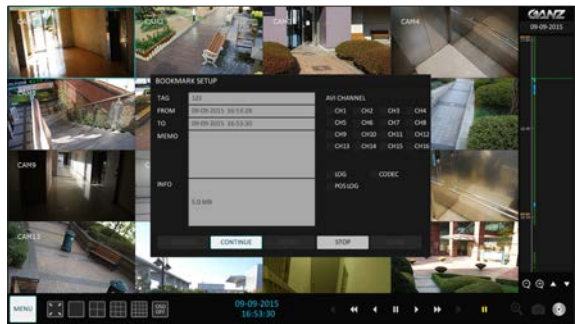

Archiving

To start the Archive menu

Using the Archive menu during playback

1. During the playback, click **<NEW ARCHIVE(📁)>**.
2. The "ARCHIVING SETUP" window appears where you can reserve the data.
3. Click **<MENU(MENU)>** in the lower left corner and select the **<ARCHIVING>** menu.
4. Press the **[ARCHIVE]** button on the remote control.

Using the Archive menu during monitoring

1. Click **<MENU(MENU)>** in the lower left corner and select the **<ARCHIVING>** menu.
2. Press the **[ARCHIVE]** button on the remote control.

Archive

You can archive the searched data or reserve it.

1. From the **<ARCHIVING>** menu, select **<NEW ARCHIVING>**.
2. Select a date for the archive from the calendar in the left.
 - ✓ The date containing recording data will be marked in a colored box.
 - FIRST : The first date of recording is automatically selected.
 - LAST : The last date of recording is automatically selected.
3. Check the **<FROM>** and **<TO>** times.
 - ✓ Drag the timeline to specify the start and end time.
4. Mark the **<LOG>**, **<CODEC>**, **<PLAYER>** and **<POS LOG>** checkboxes and select to include the archiving.
5. Click **<QUERY>**.
 - ✓ The results will be listed in **<ARCHIVING INFO>**.
 - ✓ The maximum backup capacity for one time is 20GB.
 - ✓ If the archiving request exceeds 20GB, the end time will be adjusted to within 20GB.
6. If you want to import to a storage device, connect it to the NVR and click **<EXPORT>**.
7. If you just want to reserve the data, click **<RESERVE>**.
 - ✓ If the **<TAG NAME>** dialog appears, enter the name and click **<OK>**.
 - ✓ Click **<RESERVE>** to save it to the HDD.

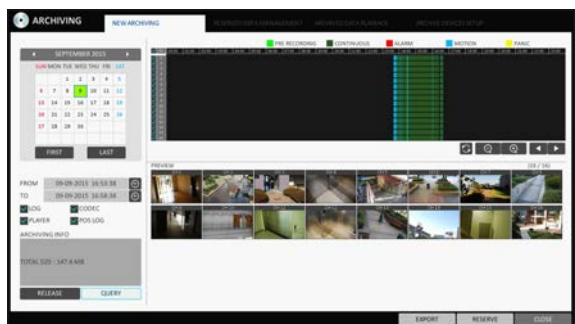
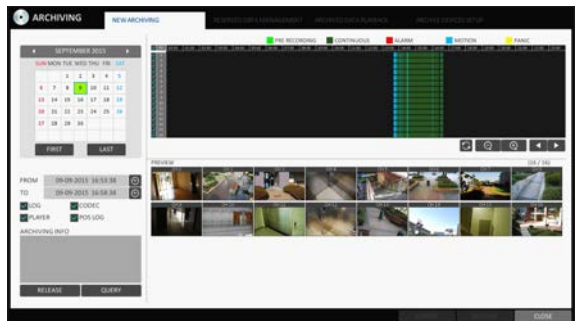

- ✓ Using **<RESERVE>** will compromise the recording days available. When you have archived the reserved data to an external device, it is recommended to delete the internal reserved data.
8. To exit the Archive menu, click **<CLOSE>**.

Archiving

Reserved data management

You can search for the reserved data and delete or import it to a storage device.

- From the <ARCHIVING> menu, select <RESERVED DATA MANAGEMENT>. The reserved data will be listed.
- Select a data type from <AVI> and <SNAPSHOT>.
 - AVI : Searches AVI video files stored in the NVR.
 - SNAPSHOT : Searches captured snapshots stored in the NVR.
- If you want to play the data, double-click a desired data item or click it and select <PLAYBACK>.
- If you want to import to a storage device, connect it to the NVR and click <EXPORT>.
- If you want to delete the reserved data, click <✕> next to the list. Click <RELEASE ALL> to cancel reserving the whole page at once.
- To exit the Archive menu, click <CLOSE>.



Playing the archived data

You can search the storage device for the archived data and check the details of or play it.

- Connect the storage device containing the archived data.
- When the storage device is recognized, click <SEARCH>.



- To view the details, click <📄> next to the list.
 - Click <VERIFY INTEGRITY> to check if the data is corrupt or incomplete.
- Select an item to play from the list and click <PLAYBACK>.
- To exit the Archive menu, click <CLOSE>.



Archive Devices Setup

Provide the FTP server information for archiving data in the HDD before testing the transfer.

1. From the <ARCHIVING> menu, select <ARCHIVE DEVICES SETUP>.
2. Move to the FTP information box.
3. Fill in each item using a virtual keyboard.
 - HOST NAME : enter the address at which you can access the server.
 - PORT : enter the port number to which you can access the server.
 - USER NAME : enter the user ID with which you can access the server.
 - PASSWORD : enter the connection password.
 - DIRECTORY : specify the archiving path.
4. When all information is filled, click <CONNECTION TEST> to check the connection status.
5. To apply the change, click <APPLY> in the bottom of the screen.
6. When done, press the [EXIT] button on the remote control or click <CLOSE> in the lower screen to return to the previous menu.



Web Viewer

What is the Web Viewer?

The Web Viewer is an application software program for a PC (for web browser) that provides user-friendly interface for easier access and use over the network, to access NVR remotely, view or search live / recorded videos and control NVR.

System Requirements

The following is the minimum hardware and operating system requirements to run Web RA.

Operating System	Windows XP Professional Windows Vista Home Basic / Premium Window 7
Web browsers	Internet Explorer 7.0 or later/Mozilla Firefox 3.6/Google Chrome 4.1/Opera 10 Some web browsers other than Internet Explorer may not fully function.
CPU	Intel Pentium 2.0 GHz
Memory	512 MB
Display	16-bit 1024 x 768 High Color
Hard Disk Drive	50MB (space required for installing the web viewer) *Additional HDD space is required for saving your recordings. The file size of your recording may differ depending on the specified quality.

Connection

Open a browser and enter the IP address of NVR, or type the URL in the address bar.

To connect to the NVR from inside

- Check the "**Network Status**" and verify the **<IP ADDRESS>** and **<WEB SERVICE PORT>** of the NVR. (page 53)
- Enter the IP address and web service port in the address bar of the browser.
Ex) `http://192.168.1.200:8080`

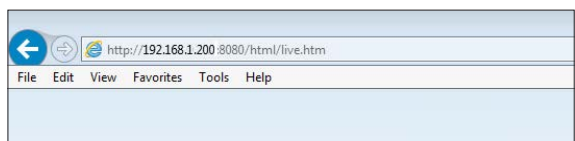

To connect to the NVR from outside

- **Using the IP address**
 - Check the "**Network Status**" and verify the **<EXTERNAL IP ADDRESS>** and **<WEB SERVICE PORT>** of the NVR. (page 53)
 - If using a fixed (external) IP, enter the external IP that is specified in the NVR in the address bar of the web browser.
Ex) If the internal IP address is set to "http://222.112.4.48:8080" (192.xxx.xxx.xxx), no access from outside is allowed.
- **Using the URL**
 - Check the "**Network Status**" and verify the **<DDNS ADDRESS>** and **<WEB SERVICE PORT>** of the NVR. (page 53)
 - Enter the DDNS address and web service port in the address bar of the browser.
Ex) `http://00115f123456.dvrlink.net:8080`
- ✓ In a router network, you have to set the "Port Forwarding" and "DMZ Setting" to allow access from outside.
- ✓ For the necessary settings of the router, refer to the user manual of the router or contact the manufacturer of the router.

1. Provide the user ID and password.
 - ✓ The default User name : ADMIN; the default password is 1234.



2. Click the upper warning bar to install the ActiveX.
 - ✓ If you fail to download the ActiveX control, move to **Tools** → **Internet Options** → **Security** → **Custom Level** → Download unsigned ActiveX control, and change its setting from "Disable (recommended)" to "Enable", and then click OK.

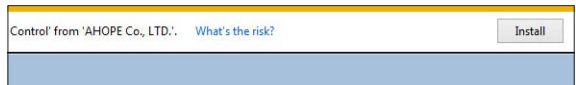

3. Click <Install>.
4. When the installation is complete, you will see the live screen.



Web Viewer

Live

Live Screen At a Glance



No.	Item	Description
1	View selection tab	You can switch to the live, playback and setup screen and check the provided information.
2	Live	Display the live screen of the currently connected NVR.
3	Split Mode	Select and switch to a desired split-screen mode.
4	Sequence	Set the sequence mode, switch to the next camera, zoom the screen or select the full screen mode.
	Status	Show the connection status of each channel.
	Log	Show the log.
5	PTZ	You can control PTZ cameras connected to each channel. (Only for PTZ cameras.)
	Refresh Time	Set the interval at which the NVR Status is refreshed.
	Refresh	Load the NVR Status immediately.

No.	Item	Description
6	Voice transmission	With the microphone, your voice will be transmitted to the NVR, or you can turn on or off the output of the voice signal.
7	Channel	Select a channel listed in the screen.
8	Save	Save the live video on the screen.
	Print	Print out the current screen.
	Capture	Capture the selected image.
	ActiveX Settings	Configure the ActiveX settings or specify the saving path of the captured image.

Switching the split mode

Click the Switch button to switch the mode as follows:



<1-split Mode>

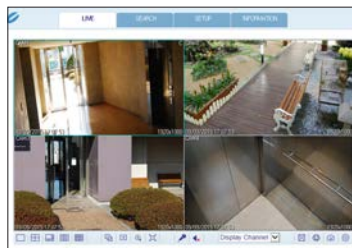

<4-split Mode>



<8-split Mode>



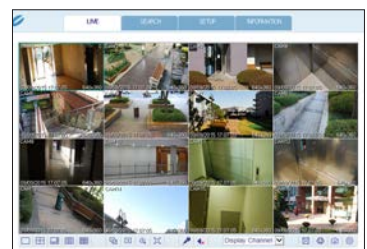

<9-split Mode>



<16-split Mode>

Web Viewer



To save the video

1. Click <  > to start saving.
2. The video from the selected channel will be saved to the PC in the AVI format. (Default path: C:\SaveFolder)
Click <  > again to stop saving. Click <  > to display the context menu where you can change the saving path.



Print

1. Click <  >.
2. The current screen will be printed with the printer connected to the PC.

Screen capture

1. Click <  >.
2. The current screen of the selected channel will be saved to the path specified in the PC. (Default path: C:\SaveFolder) Click <  > to display the context menu where you can change the saving path.

ActiveX Settings

1. Click <  >.
2. When the setup screen appears, you can change the settings of the render type, audio, capture and saving path as well as the video streaming.
 - Render : DirectDraw is recommended in order to enable the hardware acceleration.
3. If you want to change the saving path, click <  > (Save Folder) and specify a new path.
The Windows Vista user cannot change the saving path.
4. Change the streaming settings according to the PC specification and network environment.
Auto mode is recommended.
 - Sync : If this option is set, the audio signal will be synchronized with the video signal. However, you may encounter a delay due to buffering for the synchronization.
 - Live CH : Set the audio signal to use in live monitoring mode.
 - I Frame Only : Only the I frames (key frames) will be transferred.
 - Type
 - Auto : The NVR will optimize the quality and FPS to the network status and specification of the connected PC before transferring the data.
 - Main : The video will be transferred in high definition (HD).
 - Second : The video will be transferred in a medium definition (SD).
5. When done, click < **OK** > to save your settings.

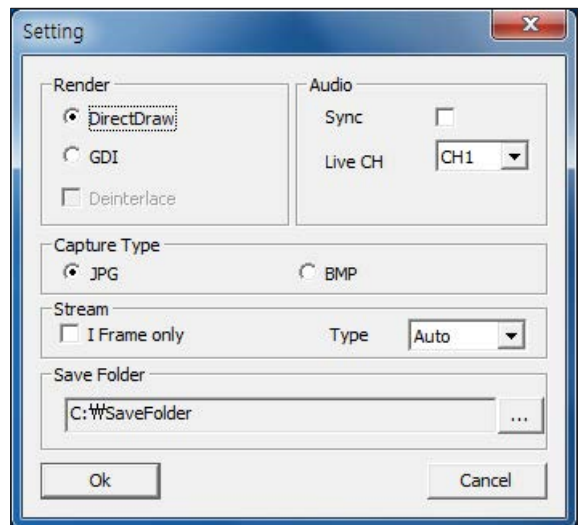

Status tab

Click <Status> at the bottom of the screen.
 You can check the event occurrence for each channel of the connected NVR.

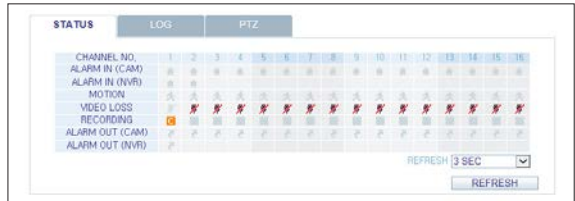

Log tab

Click <Log> at the bottom of the screen.
 You can check the log of the connected NVR.



PTZ tab

Click <PTZ> at the bottom of the screen.
 You can control the operations of a PTZ camera.
 Adjust the focus, zooming and iris of the camera.
 You can use the arrow buttons to control the operations of the camera.

- PRESET : Move the camera in a predefined direction.
- AUXILIARY FUNCTION : If the installed camera supports Auxiliary Command, you can use various special commands provided by each camera manufacturer.



Web Viewer

Search

Click <SEARCH> to display the remote control screen for the NVR.

Search Viewer at a Glance

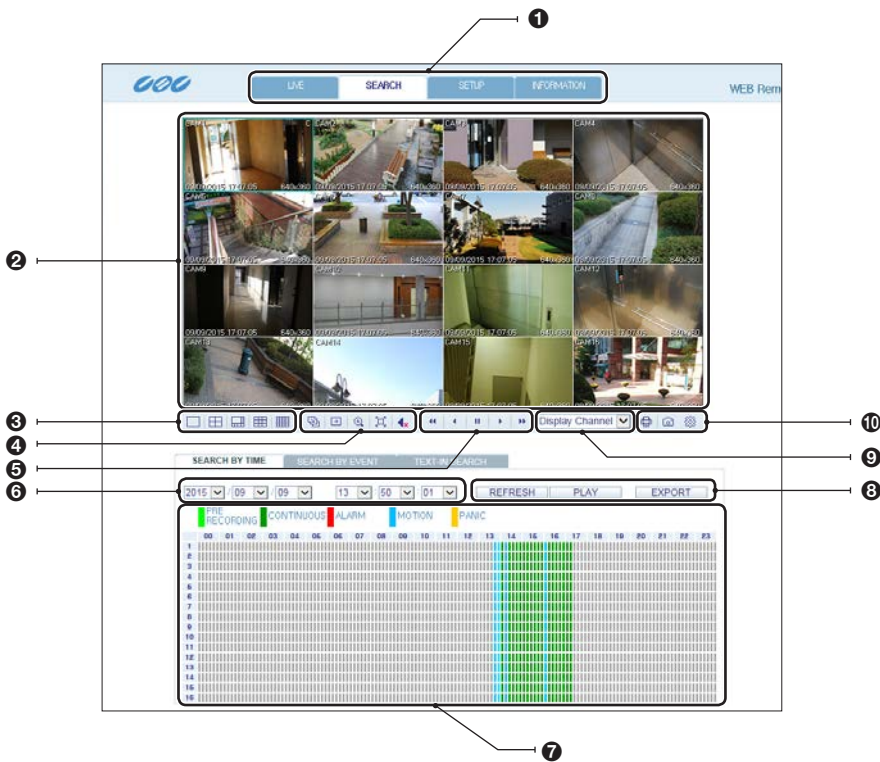

No.	Item	Description
1	View selection tab	You can switch to the live, playback and setup screen and check the provided information.
2	Playback Screen	Play the recording data.
3	Split Mode	Select and switch to a desired split-screen mode.
4	Sequence	Set the sequence mode, switch to the next camera, zoom the screen or select the full screen mode. You can turn on/off the voice signal.
5	Play button bar	You can control the playback screen.

No.	Item	Description
6	Time Selection	Specify the start time of playback.
7	Time Line	Indicates the status of the recorded data.
	REFRESH	Reload the time line.
8	PLAY	Play the video that satisfies your search criteria.
	Export	Archive the video that satisfies your search criteria.
9	Channel Selection	Select a channel listed in the screen.
	Screen	Print out the current screen.
10	Image Capture	Capture the selected image.
	ActiveX Settings	Configure the ActiveX settings or specify the saving path of the captured image.

Search by time

Use the timeline to search for the data recorded in the NVR.

1. Select a date that you want to search.
2. Click <REFRESH>.
3. Check the existence of recording data in the bottom time line and specify the time range for your search. You can specify the start time by moving the time bar.
4. Click <PLAY>.
 - > REFRESH : If your changes are not applied to the current screen, reload the changes.
 - > PLAY : Play the searched video.
 - > Export : Archive the recorded video.

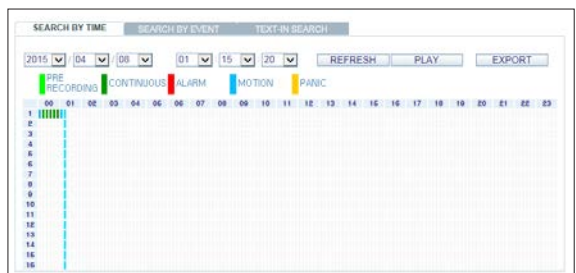

Web Viewer

Search by event

You can sort the recording data items by event to facilitate your search.

1. Mark the checkbox of the event that you want to search for.
2. Specify the start and end dates and times for your log search.
3. Set the display order of the items found.
 - ▶ LATEST : The most recent event will be listed on top.
 - ▶ OLDEST : The earliest event will be listed on top.
4. Click <SEARCH>. You can check the log for your search at the bottom of the screen.
5. Select a log to play the recording data.

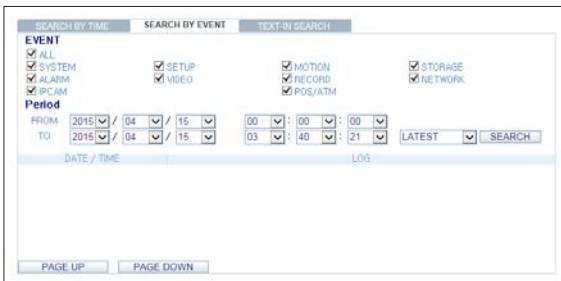

Text-in Search

You can search for the recorded data in NVR by text.

1. Enter your desired text to search for in ITEM KEYWORD, and then click the check boxes such as MATCH CASE, MATCH WHOLE WORD ONLY, etc.
2. Select the check box(es) of channel(s) to search for.
3. Select your desired Start/End date and time to perform the log search.
4. Specify the displaying order for the searched items.
 - ✓ Refer to the "Search by event" for displaying order of searched items. (page 102)
5. Press the <SEARCH> button. You can check the log resulted from the search near the bottom.
6. When selecting the log, you can watch the recorded video for corresponding event.

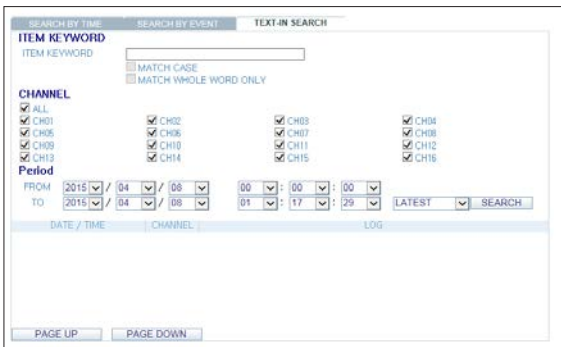

Setup

Click <SETUP> to display the remote control screen for the NVR.
When done, click <APPLY> to apply the changes to the remotely connected NVR.

- ✓ If the NVR is in process of system or record setting, the remote control will be disabled.
- ❗ If you change the settings remotely at will, the major 'Record Settings' of the NVR may be changed, which is not recommended at all.

Setup Viewer at a Glance



Camera

To name the camera title

You can name the camera title that is displayed on each channel screen. Select a channel to name and provide a new title. Then, click <APPLY> to apply it.

- ✓ You can enter up to 9 alphanumeric characters for the camera title.

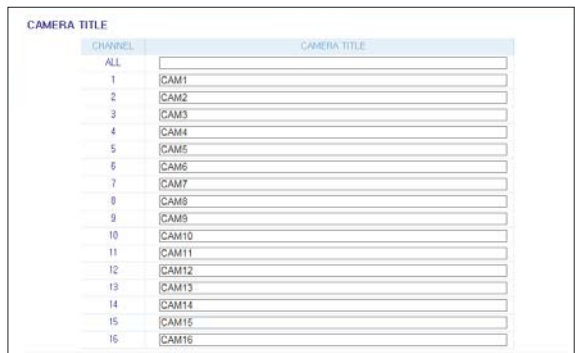

Web Viewer

Camera Setting

You can set the image and exposure of each channel. When done, click **<APPLY>** to apply the changes.

- ✓ The default color value is **<50>**. (Brightness, Contrast, Tint, Color)
- ✓ If you change the default settings, the video from the NVR or the video color may not be displayed properly.
- ✓ To apply the same settings to another channel's camera, click **<COPY SETTINGS TO>** button and set the checkbox.
- ✓ To cut the POE power, press the **<POE POWER OFF>** button.

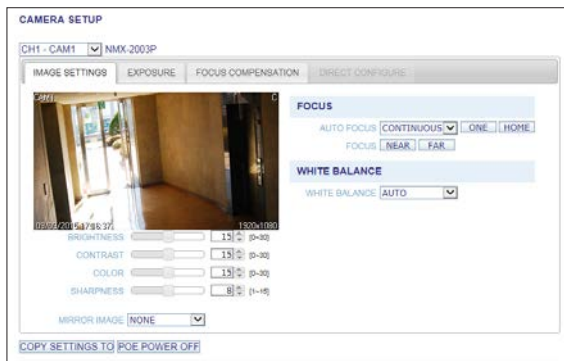

Covert Setting

You can set to hide the video of a specific camera from a specific user. Set to hide the camera video so that a specific user or user group can not view. To change the covert settings from user group to user, move to the **<USER>** menu and make necessary changes.

When done, click **<APPLY>** to apply the changes.

- SHOW AS : Sets how to display video of the **<COVERT CHANNEL>** channel.
 - NO VIDEO : Appears to have no video for the channel.
 - COVERT : Shows nothing for the Live screen only.

COVERT SETUP					
CHANNEL	ADMIN	MANAGER	USER	LOG OUT	
ALL	<input type="checkbox"/>	<input type="checkbox"/>	<input type="checkbox"/>	<input type="checkbox"/>	
CAM1	<input type="checkbox"/>	<input type="checkbox"/>	<input type="checkbox"/>	<input type="checkbox"/>	
CAM2	<input type="checkbox"/>	<input type="checkbox"/>	<input type="checkbox"/>	<input type="checkbox"/>	
CAM3	<input type="checkbox"/>	<input type="checkbox"/>	<input type="checkbox"/>	<input type="checkbox"/>	
CAM4	<input type="checkbox"/>	<input type="checkbox"/>	<input type="checkbox"/>	<input type="checkbox"/>	
CAM5	<input type="checkbox"/>	<input type="checkbox"/>	<input type="checkbox"/>	<input type="checkbox"/>	
CAM6	<input type="checkbox"/>	<input type="checkbox"/>	<input type="checkbox"/>	<input type="checkbox"/>	
CAM7	<input type="checkbox"/>	<input type="checkbox"/>	<input type="checkbox"/>	<input type="checkbox"/>	
CAM8	<input type="checkbox"/>	<input type="checkbox"/>	<input type="checkbox"/>	<input type="checkbox"/>	
CAM9	<input type="checkbox"/>	<input type="checkbox"/>	<input type="checkbox"/>	<input type="checkbox"/>	
CAM10	<input type="checkbox"/>	<input type="checkbox"/>	<input type="checkbox"/>	<input type="checkbox"/>	
CAM11	<input type="checkbox"/>	<input type="checkbox"/>	<input type="checkbox"/>	<input type="checkbox"/>	
CAM12	<input type="checkbox"/>	<input type="checkbox"/>	<input type="checkbox"/>	<input type="checkbox"/>	
CAM13	<input type="checkbox"/>	<input type="checkbox"/>	<input type="checkbox"/>	<input type="checkbox"/>	
CAM14	<input type="checkbox"/>	<input type="checkbox"/>	<input type="checkbox"/>	<input type="checkbox"/>	
CAM15	<input type="checkbox"/>	<input type="checkbox"/>	<input type="checkbox"/>	<input type="checkbox"/>	
CAM16	<input type="checkbox"/>	<input type="checkbox"/>	<input type="checkbox"/>	<input type="checkbox"/>	
SHOW AS	<input type="checkbox"/> COVERT	<input type="checkbox"/> COVERT	<input type="checkbox"/> COVERT	<input type="checkbox"/> COVERT	

Motion Setting

Specify the use of motion detection and reaction for each channel and set also the daytime/nighttime options. Select a channel. Set the mask area and activation and specify the daytime range.

When done, click <APPLY> to apply the changes.

- ✓ For information about how to set the motion area, refer to "Motion Area Setup". (page 39)

MOTION SENSOR		
ACTIVATION	AREA SETUP	
ALL	ACTIVATION	MOTION MARK
CAM1	ON	OFF
CAM2	ON	OFF
CAM3	ON	OFF
CAM4	ON	OFF
CAM5	ON	OFF
CAM6	ON	OFF
CAM7	ON	OFF
CAM8	ON	OFF
CAM9	ON	OFF
CAM10	ON	OFF
CAM11	ON	OFF
CAM12	ON	OFF
CAM13	ON	OFF
CAM14	ON	OFF
CAM15	ON	OFF
CAM16	ON	OFF

MOTION SENSOR

select GENERAL

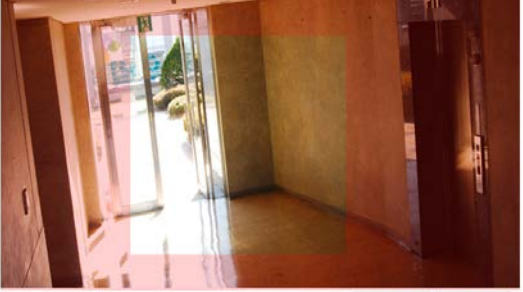

SELECT ALL Deselect ALL

CHANNEL: 1

DAYTIME SET: 9:00 - 18:00

DAYTIME SENSITIVITY: 10 MINIMUM BLOCKS: 1

NIGHTTIME SENSITIVITY: 10 MINIMUM BLOCKS: 1

Web Viewer

Web Viewer

PTZ Setting

You can set the camera ID, protocol, baud rate and data transmission speed for each channel.

- ✓ For information about how to set the PTZ, refer to "PTZ Settings". (page 40)

PTZ SETUP

CHANNEL	RS485	ADDRESS	PROTOCOL	BAUD RATE
CAM1	<input type="checkbox"/>	0	PELCO-D	9600
CAM2	<input type="checkbox"/>	0	PELCO-D	9600
CAM3	<input type="checkbox"/>	0	PELCO-D	9600
CAM4	<input type="checkbox"/>	0	PELCO-D	9600
CAM5	<input type="checkbox"/>	0	PELCO-D	9600
CAM6	<input type="checkbox"/>	0	PELCO-D	9600
CAM7	<input type="checkbox"/>	0	PELCO-D	9600
CAM8	<input type="checkbox"/>	0	PELCO-D	9600
CAM9	<input type="checkbox"/>	0	PELCO-D	9600
CAM10	<input type="checkbox"/>	0	PELCO-D	9600
CAM11	<input type="checkbox"/>	0	PELCO-D	9600
CAM12	<input type="checkbox"/>	0	PELCO-D	9600
CAM13	<input type="checkbox"/>	0	PELCO-D	9600
CAM14	<input type="checkbox"/>	0	PELCO-D	9600
CAM15	<input type="checkbox"/>	0	PELCO-D	9600
CAM16	<input type="checkbox"/>	0	PELCO-D	9600

Privacy Mask

You can enable a camera channel's privacy masking area and its mask color.

PRIVACY MASK

ACTIVATION		AREA SETUP	
	ACTIVATION		MASK COLOR
ALL	<input type="checkbox"/>		
CAM1	ON	BLACK	
CAM2	ON	BLACK	
CAM3	ON	BLACK	
CAM4	ON	BLACK	
CAM5	ON	BLACK	
CAM6	ON	BLACK	
CAM7	ON	BLACK	
CAM8	ON	BLACK	
CAM9	ON	BLACK	
CAM10	ON	BLACK	
CAM11	ON	BLACK	
CAM12	ON	BLACK	
CAM13	ON	BLACK	
CAM14	ON	BLACK	
CAM15	ON	BLACK	
CAM16	ON	BLACK	

INSTALLATION MODE

The network accessibility to the camera is defined by the camera's operation mode.

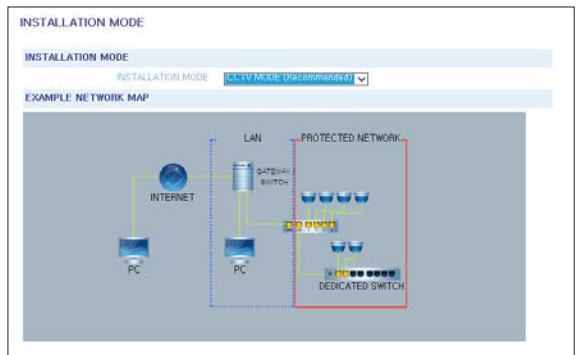

Display

OSD Setting

Configure the settings for the time, title, boundary, icon and language that will be displayed on the screen.

Make changes to each item of the OSD menu and click <APPLY> to apply the changes.

- ✓ For details about each displayed item, refer to "OSD". (page 43)

The screenshot shows the OSD menu with the following settings:

- CAMERA TITLE: ON
- RECORDING MODE ICON: ON
- AUDIO ICON: ON
- STATUS BAR ON FULL SCREEN MODE: AUTO HIDE
- TIMELINE ON FULL SCREEN MODE: AUTO HIDE
- BORDER LINE: ON
- BORDER COLOR: DARKGRAY
- USER NAME: ON
- LANGUAGE: ENGLISH

Monitor Settings

You can set the interval of an active sequence. Specify the interval and click <APPLY> to apply it.

The screenshot shows the MONITOR menu with the following setting:

- SEQUENCE DWELL: 5 SEC

Audio

Audio/Buzzer

You can configure the settings of the voice and audio signal.

- ✓ For details about each displayed item, refer to "Audio Setup". (page 48)

The screenshot shows the AUDIO and BUZZER menu with the following settings:

- DEFAULT LIVE AUDIO CHANNEL: OFF
- NETWORK AUDIO TRANSMISSION: ON
- RECEIVE NETWORK AUDIO: ON
- REMOTE CONTROLLER: ON

Web Viewer

User

User Management

You can add a user account and change the password.

- ✓ For details about each displayed item, refer to "User Setting". (page 49)

To add a user, click <ADD> and provide the user information. If you want to delete the user click <DELETE> next to it. When done, click <APPLY> to apply the change.

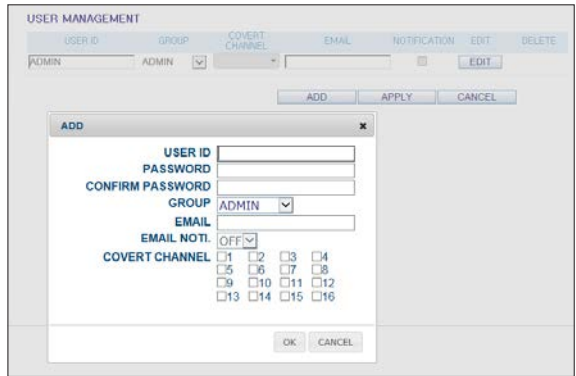

Group Permission Setting

You can grant different user groups different permissions to a specific menu.

Mark the checkboxes of the menu items accessible by the user group.

When done, click <APPLY> to apply the changes.

- ✓ For more information about the accessible menu items, refer to "Group Authority". (page 50)

GROUP AUTHORITY		
	Manager	User
SEARCH	<input checked="" type="checkbox"/>	<input type="checkbox"/>
ARCHIVING	<input type="checkbox"/>	<input type="checkbox"/>
SYSTEM SETUP	<input checked="" type="checkbox"/>	<input type="checkbox"/>
RECORD SETUP	<input checked="" type="checkbox"/>	<input type="checkbox"/>
EVENT ACTION CONTROL	<input checked="" type="checkbox"/>	<input checked="" type="checkbox"/>
LISTEN TO AUDIO	<input checked="" type="checkbox"/>	<input checked="" type="checkbox"/>
MIC	<input checked="" type="checkbox"/>	<input checked="" type="checkbox"/>
REMOTE LOG IN	<input type="checkbox"/>	<input type="checkbox"/>
SHUTDOWN	<input checked="" type="checkbox"/>	<input checked="" type="checkbox"/>

Network

IP Setting

You can check the network connection status and change the baud rate.

Change the maximum transfer rate and click <APPLY> to apply it.

- ✓ For more information about each network entry, refer to "IP Setup". (page 51)

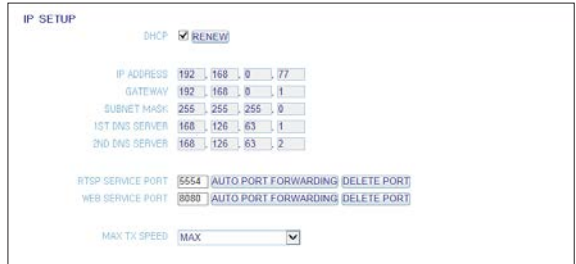

The screenshot shows the 'IP SETUP' configuration page. At the top, there is a 'DHCP' section with a checked 'RENEW' option. Below this, several fields are displayed with their values: IP ADDRESS (192.168.0.77), GATEWAY (192.168.0.1), SUBNET MASK (255.255.255.0), 1ST DNS SERVER (168.126.83.1), and 2ND DNS SERVER (168.126.83.2). There are also sections for 'RTSP SERVICE PORT' (5554) and 'WEB SERVICE PORT' (8080), each with 'AUTO PORT FORWARDING' and 'DELETE PORT' links. At the bottom, the 'MAX TX SPEED' is set to 'MAX'.

DDNS Setting

You can configure the DDNS settings so that remote users who are connected to the network can access remotely.

Change the DDNS settings and click <APPLY> to apply the changes.



The screenshot shows the 'DDNS' configuration page. It includes a 'DDNS' section with a dropdown menu set to 'ON'. Below this, the 'DDNS SERVER' is set to 'dvrlink.net'. There are also fields for 'NVR NAME' (001150a23b6), 'USER ID', 'PASSWORD', and 'NVR ADDRESS' (001150a23b6.dvrlink.net).

Web Viewer

Email Setting

You can register and test an email address so that an email notification is delivered at a specific interval or if an event occurs. Provide the necessary information and click <APPLY> to apply it.

✓ For more information, refer to "Email". (page 52)

EMAIL

SERVER

PORT 25

SECURITY OFF

USER

PASSWORD

TEST EMAIL

TEST

Security Setting

For security purpose, you can set whether to use encryption and its method, and configure IP filtering. Change the system network settings and click <APPLY > to apply the changes.

✓ For more information, refer to "Security". (page 55)

SECURITY

ENCRYPTION IP FILTER

RTSP SERVICE

RTSP ENCRYPTION ENABLE OFF

RTSP ENCRYPTION METHOD SEED_128

WEB SERVICE

HTTPS ENABLE OFF

HTTP AUTHENTICATION METHOD BASIC

SECURITY

ENCRYPTION IP FILTER

IP FILTER ENABLE OFF

IP FILTER RULE ALLOW LIST

TYPE	LIST

ADD

System

Date/Time Setting

Specify the current date and time.
When done, click <APPLY> to apply the changes.

- ✓ For more information about each of the time and date settings, refer to "Date/Time". (page 56)

System Management

You can configure the access settings of: log in, log out, and auto logout.

- Network F/W upgrade : Checks for the latest firmware available on the network with the given URL and update it.
To apply a new firmware, click <FW UPGRADE> and provide the firmware URL.
- FACTORY DEFAULT : Return the NVR settings to the factory default.
- SYSTEM DATA : Save the system settings or get the system information from other device.
- REBOOT SYSTEM : You can reboot the NVR main body remotely.
- ✓ This function is available only when the NVR main body is displayed in LIVE screen.

Web Viewer

System Information

You can check information of system firmware version, disk space, and network settings, as well as the status information of network connection and alarm I/O.

SYSTEM INFORMATION	
FW VERSION	39310.1.700014.32
LAST FW UPDATE DATE	09-09-2015
HW VERSION	MIPA/310
DISK CAPACITY	3726.0 GB
DISK USAGE	108.4 GB
NUMBER OF DISKS	2
IP ADDRESS	192.168.0.93
MAC ADDRESS	0011590a46f
DDNS ADDRESS	0011590a46f.dvlink.net
RTSP SERVICE PORT	5554
WEB SERVICE PORT	8080
RESOLUTION	VGA(1080P-60)
SYSTEM ID	SYSTEMID

STATUS	
CAMERA CONNECTION	<input checked="" type="checkbox"/> 1 <input type="checkbox"/> 2 <input type="checkbox"/> 3 <input type="checkbox"/> 4 <input type="checkbox"/> 5 <input type="checkbox"/> 6 <input type="checkbox"/> 7 <input type="checkbox"/> 8 <input type="checkbox"/> 9 <input type="checkbox"/> 10 <input type="checkbox"/> 11 <input type="checkbox"/> 12 <input type="checkbox"/> 13 <input type="checkbox"/> 14 <input type="checkbox"/> 15 <input type="checkbox"/> 16
ALARM IN (CAMERA)	<input type="checkbox"/> 1 <input type="checkbox"/> 2 <input type="checkbox"/> 3 <input type="checkbox"/> 4 <input type="checkbox"/> 5 <input type="checkbox"/> 6 <input type="checkbox"/> 7 <input type="checkbox"/> 8 <input type="checkbox"/> 9 <input type="checkbox"/> 10 <input type="checkbox"/> 11 <input type="checkbox"/> 12 <input type="checkbox"/> 13 <input type="checkbox"/> 14 <input type="checkbox"/> 15 <input type="checkbox"/> 16
ALARM IN (IVR)	<input type="checkbox"/> 1 <input type="checkbox"/> 2
ALARM OUT(CAMERA)	<input type="checkbox"/> 1 <input type="checkbox"/> 2 <input type="checkbox"/> 3 <input type="checkbox"/> 4 <input type="checkbox"/> 5 <input type="checkbox"/> 6 <input type="checkbox"/> 7 <input type="checkbox"/> 8 <input type="checkbox"/> 9 <input type="checkbox"/> 10 <input type="checkbox"/> 11 <input type="checkbox"/> 12 <input type="checkbox"/> 13 <input type="checkbox"/> 14 <input type="checkbox"/> 15 <input type="checkbox"/> 16
ALARM OUT (IVR)	<input type="checkbox"/> 1

Control Device Setting

Set the connection of both the remote control and the keyboard control. Change the communication settings and click <APPLY> to apply the changes.

CONTROL DEVICE			
DEVICE	SYSTEM ID	PROTOCOL	BAUD RATE
0	<input type="checkbox"/> <input checked="" type="checkbox"/>	<input type="checkbox"/> D-Max <input checked="" type="checkbox"/>	<input type="checkbox"/> 9600 <input checked="" type="checkbox"/>

✔ For more information about each communication item, refer to "Control Device". (page 61)

Security Setting

For security, you can set to apply reinforced password policy (to system, search/backup) and control accessing audio and snapshot. Change the system security settings and click <APPLY > to apply the changes.

SECURITY	
AUDIO SUPPORT	<input checked="" type="checkbox"/> ON <input type="checkbox"/> OFF
SNAPSHOT SUPPORT	<input checked="" type="checkbox"/> ON <input type="checkbox"/> OFF
ENHANCED PASSWORD RULE	<input type="checkbox"/> ON <input checked="" type="checkbox"/> OFF
PASSWORD CHECK WHEN SEARCH/BACKUP	<input type="checkbox"/> ON <input checked="" type="checkbox"/> OFF

✔ For more information, refer to "Security". (page 63)

Storage

Device Information

You can check a list of internal/external storage devices connected to the NVR as well as the recording time information of each device.

DISK INFORMATION

internal external

	START TIME	END TIME	STATUS	CAPACITY	MODEL	S.M.A.R.T. STATUS
ALL	01-01-2015 01:10:23	01-07-2015 03:00:37	-	-	-	-
DISK 1	01-01-2015 01:10:23	01-07-2015 03:00:37	IN USE	232.9 GB	ST3250312CS	NORMAL
DISK 2	-	-	-	-	-	-
DISK 3	-	-	-	-	-	-
DISK 4	-	-	-	-	-	-
DISK 5	-	-	-	-	-	-

Checking the disk operation

You can set the overwrite mode and recording period of a storage device, or format the disk.

DISK OPERATIONS

DISK WRITE MODE:

RECORDING TIME LIMIT:

DISK FORMAT:

S.M.A.R.T Status

You can check the S.M.A.R.T status for each of the internal and external devices.

- ✓ What is S.M.A.R.T?
This is a sort of HDD self-diagnosis tool that detects any error on the system and alerts the user if an error occurs.

S.M.A.R.T. SETUP

internal external

	Disk 1	Disk 2	Disk 3	Disk 4	Disk 5
S.M.A.R.T. STATUS	NORMAL	-	-	-	-

Web Viewer

Event

Alarm Out

Specify the alarm output conditions with the work schedule. When done, click <APPLY> to apply the changes.

- ✓ For more information about the alarm output and ON/OFF schedule, refer to "Alarm Out". (page 67)

ALARM OUT ON/OFF SCHEDULE

ALL	NAME	OPERATION	DURATION
1	CAM-A01	N/O	5 SEC
2	CAM-A02	N/O	5 SEC
3	CAM-A03	N/O	5 SEC
4	CAM-A04	N/O	5 SEC
5	CAM-A05	N/O	5 SEC
6	CAM-A06	N/O	5 SEC
7	CAM-A07	N/O	5 SEC
8	CAM-A08	N/O	5 SEC
9	CAM-A09	N/O	5 SEC
10	CAM-A010	N/O	5 SEC
11	CAM-A011	N/O	5 SEC
12	CAM-A012	N/O	5 SEC
13	CAM-A013	N/O	5 SEC
14	CAM-A014	N/O	5 SEC
15	CAM-A015	N/O	5 SEC
16	CAM-A016	N/O	5 SEC
AO1	AO1	N/O	5 SEC

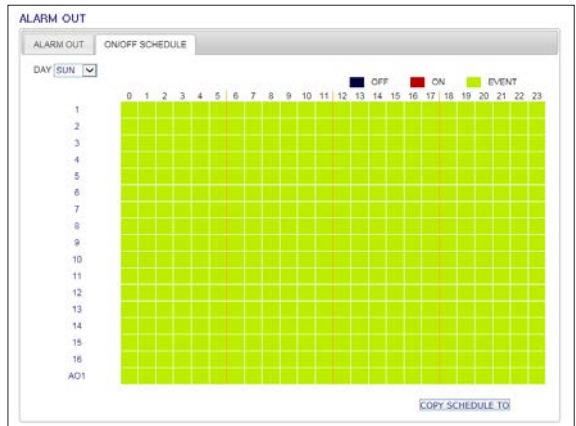

Event Notification

You can set desired event actions triggered by an event, such as <BUZZER OUT>, <DISPLAY>, <EMAIL> and <FTP> notifications.

Set the dwell time for buzzer or pop-up display, or set the email or FTP destination settings and then click <APPLY> to save your changes.

- ✓ For more information about the event notification, refer to "Event Notification". (page 68)

Alarm Sensor

You can configure the settings of the alarm sensor and specify the operation of the sensor if an event occurs. When done, click <APPLY> to apply the changes.

- ✓ For more information about each of the alarm sensor actions, refer to "Alarm Sensor". (page 71)

ALARM SENSOR										
ALL	TIME	OPERATION	LINKED CAMERA	ALARM OUT	PRESET	BUZZER	VIDEO POPUP	OSD POPUP	EMAIL	FTP
1	CAM-A11	N/O	1	NA	0:0:0:0:0:0	<input type="checkbox"/>	<input type="checkbox"/>	<input type="checkbox"/>	<input type="checkbox"/>	<input type="checkbox"/>
2	CAM-A12	N/O	2	NA	0:0:0:0:0:0	<input type="checkbox"/>	<input type="checkbox"/>	<input type="checkbox"/>	<input type="checkbox"/>	<input type="checkbox"/>
3	CAM-A13	N/O	3	NA	0:0:0:0:0:0	<input type="checkbox"/>	<input type="checkbox"/>	<input type="checkbox"/>	<input type="checkbox"/>	<input type="checkbox"/>
4	CAM-A14	N/O	4	NA	0:0:0:0:0:0	<input type="checkbox"/>	<input type="checkbox"/>	<input type="checkbox"/>	<input type="checkbox"/>	<input type="checkbox"/>
5	CAM-A15	N/O	5	NA	0:0:0:0:0:0	<input type="checkbox"/>	<input type="checkbox"/>	<input type="checkbox"/>	<input type="checkbox"/>	<input type="checkbox"/>
6	CAM-A16	N/O	6	NA	0:0:0:0:0:0	<input type="checkbox"/>	<input type="checkbox"/>	<input type="checkbox"/>	<input type="checkbox"/>	<input type="checkbox"/>
7	CAM-A17	N/O	7	NA	0:0:0:0:0:0	<input type="checkbox"/>	<input type="checkbox"/>	<input type="checkbox"/>	<input type="checkbox"/>	<input type="checkbox"/>
8	CAM-A18	N/O	8	NA	0:0:0:0:0:0	<input type="checkbox"/>	<input type="checkbox"/>	<input type="checkbox"/>	<input type="checkbox"/>	<input type="checkbox"/>
9	CAM-A19	N/O	9	NA	0:0:0:0:0:0	<input type="checkbox"/>	<input type="checkbox"/>	<input type="checkbox"/>	<input type="checkbox"/>	<input type="checkbox"/>
10	CAM-A110	N/O	10	NA	0:0:0:0:0:0	<input type="checkbox"/>	<input type="checkbox"/>	<input type="checkbox"/>	<input type="checkbox"/>	<input type="checkbox"/>
11	CAM-A111	N/O	11	NA	0:0:0:0:0:0	<input type="checkbox"/>	<input type="checkbox"/>	<input type="checkbox"/>	<input type="checkbox"/>	<input type="checkbox"/>
12	CAM-A112	N/O	12	NA	0:0:0:0:0:0	<input type="checkbox"/>	<input type="checkbox"/>	<input type="checkbox"/>	<input type="checkbox"/>	<input type="checkbox"/>
13	CAM-A113	N/O	13	NA	0:0:0:0:0:0	<input type="checkbox"/>	<input type="checkbox"/>	<input type="checkbox"/>	<input type="checkbox"/>	<input type="checkbox"/>
14	CAM-A114	N/O	14	NA	0:0:0:0:0:0	<input type="checkbox"/>	<input type="checkbox"/>	<input type="checkbox"/>	<input type="checkbox"/>	<input type="checkbox"/>
15	CAM-A115	N/O	15	NA	0:0:0:0:0:0	<input type="checkbox"/>	<input type="checkbox"/>	<input type="checkbox"/>	<input type="checkbox"/>	<input type="checkbox"/>
16	CAM-A116	N/O	16	NA	0:0:0:0:0:0	<input type="checkbox"/>	<input type="checkbox"/>	<input type="checkbox"/>	<input type="checkbox"/>	<input type="checkbox"/>
A1	A11	N/O	1, 2, 3, 4	NA	0:0:0:0:0:0	<input type="checkbox"/>	<input type="checkbox"/>	<input type="checkbox"/>	<input type="checkbox"/>	<input type="checkbox"/>
A2	A12	N/O	5, 6, 7, 8	NA	0:0:0:0:0:0	<input type="checkbox"/>	<input type="checkbox"/>	<input type="checkbox"/>	<input type="checkbox"/>	<input type="checkbox"/>

Web Viewer

Motion Sensor

You can set an action to execute when a motion is detected. When done, click <APPLY> to apply the changes.

- ✓ For more information about how to set the motion sensor, refer to "Motion Sensor". (page 72)

MOTION SENSOR							
CAM	EVENT PARAMETER		ACTION				
	SPEED/INTENS.	ALARM OUT	PRESET	BUZZER	VIDEO POPUP	EMAIL	FTP
ALL	-----	---		<input type="checkbox"/>	<input type="checkbox"/>	<input type="checkbox"/>	<input type="checkbox"/>
1	5 SEC	NA	00000000	<input type="checkbox"/>	<input type="checkbox"/>	<input type="checkbox"/>	<input type="checkbox"/>
2	5 SEC	NA	00000000	<input type="checkbox"/>	<input type="checkbox"/>	<input type="checkbox"/>	<input type="checkbox"/>
3	5 SEC	NA	00000000	<input type="checkbox"/>	<input type="checkbox"/>	<input type="checkbox"/>	<input type="checkbox"/>
4	5 SEC	NA	00000000	<input type="checkbox"/>	<input type="checkbox"/>	<input type="checkbox"/>	<input type="checkbox"/>
5	5 SEC	NA	00000000	<input type="checkbox"/>	<input type="checkbox"/>	<input type="checkbox"/>	<input type="checkbox"/>
6	5 SEC	NA	00000000	<input type="checkbox"/>	<input type="checkbox"/>	<input type="checkbox"/>	<input type="checkbox"/>
7	5 SEC	NA	00000000	<input type="checkbox"/>	<input type="checkbox"/>	<input type="checkbox"/>	<input type="checkbox"/>
8	5 SEC	NA	00000000	<input type="checkbox"/>	<input type="checkbox"/>	<input type="checkbox"/>	<input type="checkbox"/>
9	5 SEC	NA	00000000	<input type="checkbox"/>	<input type="checkbox"/>	<input type="checkbox"/>	<input type="checkbox"/>
10	5 SEC	NA	00000000	<input type="checkbox"/>	<input type="checkbox"/>	<input type="checkbox"/>	<input type="checkbox"/>
11	5 SEC	NA	00000000	<input type="checkbox"/>	<input type="checkbox"/>	<input type="checkbox"/>	<input type="checkbox"/>
12	5 SEC	NA	00000000	<input type="checkbox"/>	<input type="checkbox"/>	<input type="checkbox"/>	<input type="checkbox"/>
13	5 SEC	NA	00000000	<input type="checkbox"/>	<input type="checkbox"/>	<input type="checkbox"/>	<input type="checkbox"/>
14	5 SEC	NA	00000000	<input type="checkbox"/>	<input type="checkbox"/>	<input type="checkbox"/>	<input type="checkbox"/>
15	5 SEC	NA	00000000	<input type="checkbox"/>	<input type="checkbox"/>	<input type="checkbox"/>	<input type="checkbox"/>
16	5 SEC	NA	00000000	<input type="checkbox"/>	<input type="checkbox"/>	<input type="checkbox"/>	<input type="checkbox"/>

Video Loss

You can set to trigger alarm output or other actions when there is no video transfer from a camera. When done, click <APPLY> to apply the changes.

- ✓ For more information about how to set the video loss, refer to "Video Loss". (page 73)

VIDEO LOSS						
CAM	ALARM OUT		ACTION			
	PRESET	BUZZER	EMAIL	FTP		
ALL	---		<input type="checkbox"/>	<input type="checkbox"/>	<input type="checkbox"/>	
1	NA	00000000	<input type="checkbox"/>	<input type="checkbox"/>	<input type="checkbox"/>	
2	NA	00000000	<input type="checkbox"/>	<input type="checkbox"/>	<input type="checkbox"/>	
3	NA	00000000	<input type="checkbox"/>	<input type="checkbox"/>	<input type="checkbox"/>	
4	NA	00000000	<input type="checkbox"/>	<input type="checkbox"/>	<input type="checkbox"/>	
5	NA	00000000	<input type="checkbox"/>	<input type="checkbox"/>	<input type="checkbox"/>	
6	NA	00000000	<input type="checkbox"/>	<input type="checkbox"/>	<input type="checkbox"/>	
7	NA	00000000	<input type="checkbox"/>	<input type="checkbox"/>	<input type="checkbox"/>	
8	NA	00000000	<input type="checkbox"/>	<input type="checkbox"/>	<input type="checkbox"/>	
9	NA	00000000	<input type="checkbox"/>	<input type="checkbox"/>	<input type="checkbox"/>	
10	NA	00000000	<input type="checkbox"/>	<input type="checkbox"/>	<input type="checkbox"/>	
11	NA	00000000	<input type="checkbox"/>	<input type="checkbox"/>	<input type="checkbox"/>	
12	NA	00000000	<input type="checkbox"/>	<input type="checkbox"/>	<input type="checkbox"/>	
13	NA	00000000	<input type="checkbox"/>	<input type="checkbox"/>	<input type="checkbox"/>	
14	NA	00000000	<input type="checkbox"/>	<input type="checkbox"/>	<input type="checkbox"/>	
15	NA	00000000	<input type="checkbox"/>	<input type="checkbox"/>	<input type="checkbox"/>	
16	NA	00000000	<input type="checkbox"/>	<input type="checkbox"/>	<input type="checkbox"/>	

System Event

You can set event actions for disk, recording, network and system events. As same to setting event actions for normal events, you can set to trigger alarm output, buzzer, display on-screen pop-up, or send event notification via email and FTP.

SYSTEM EVENT STATUS						
EVENT TYPE	ALARM OUT		ACTION			
	BUZZER	DISK POPUP	EMAIL	FTP		
ALL		<input type="checkbox"/>	<input type="checkbox"/>	<input type="checkbox"/>	<input type="checkbox"/>	
OVERWRITE START EVENT	NA	<input type="checkbox"/>	<input type="checkbox"/>	<input type="checkbox"/>	<input type="checkbox"/>	
DISK FULL EVENT	NA	<input type="checkbox"/>	<input type="checkbox"/>	<input type="checkbox"/>	<input type="checkbox"/>	
DISK SPACE EXHAUSTED EVENT	90%	<input type="checkbox"/>	<input type="checkbox"/>	<input type="checkbox"/>	<input type="checkbox"/>	
S.M.A.R.T. EVENT	NA	<input checked="" type="checkbox"/>	<input checked="" type="checkbox"/>	<input checked="" type="checkbox"/>	<input checked="" type="checkbox"/>	
NO DISK EVENT	NA	<input checked="" type="checkbox"/>	<input checked="" type="checkbox"/>	<input checked="" type="checkbox"/>	<input checked="" type="checkbox"/>	

When done, click <APPLY> to apply the changes.

- ✓ For more information about how to set the system event, refer to "System Event". (page 74)

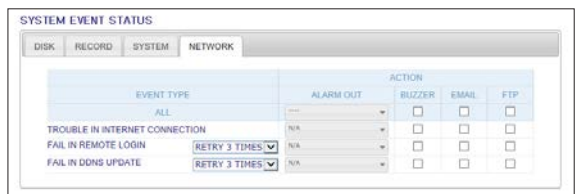
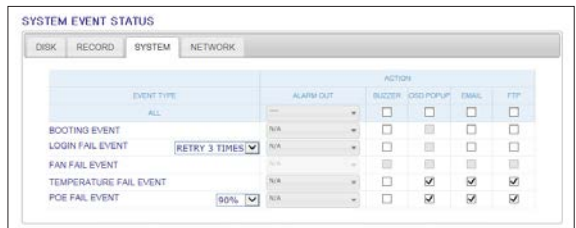

Record Setup

Record Setting

You can set the recording options for Auto or Manual mode.

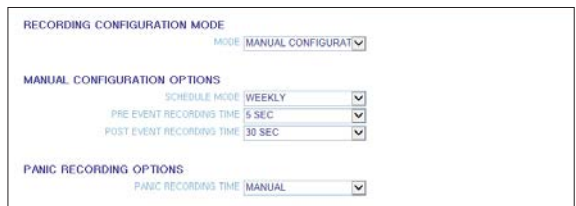

When done, click <APPLY> to apply the changes.

- ✓ For more information about how to set each mode, refer to "Operation Mode". (page 77)



Web Viewer

Continuous Recording

You can configure the settings of: continuous recording time, recording size, frame rate per second and quality. Click <▼> next to each item to display the list of values available.

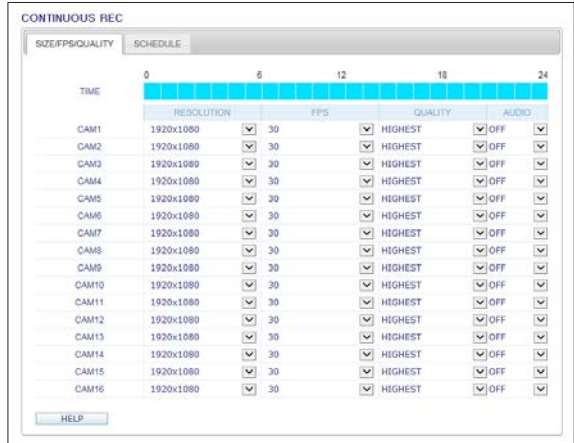

When you complete the recording size and schedule settings, click <APPLY> to apply your settings.

- ✓ For more information about the continuous recording size and schedule, refer to "Continuous Recording". (page 78)

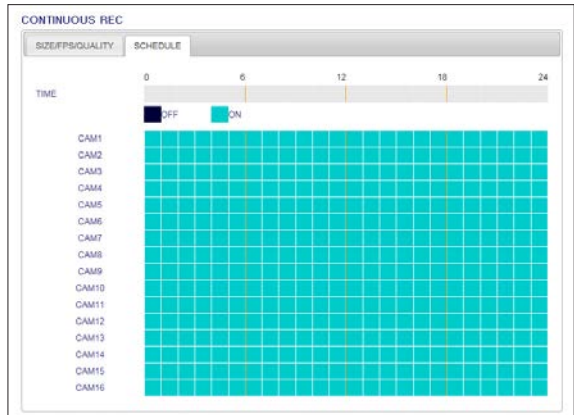

Motion Recording

Set the <SIZE/FPS/QUALITY/AUDIO> and the <SCHEDULE> to apply if a motion event occurs. Click <▼> next to each item to display the list of values available.

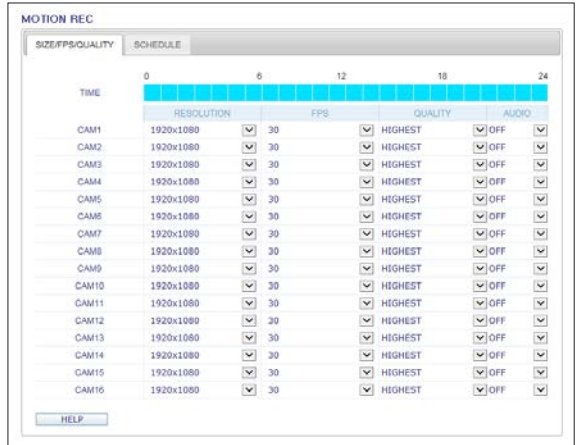

Web Viewer

Complete setting the <SIZE/FPS/QUALITY/AUDIO> for the motion recording as well as the <SCHEDULE>, and click <APPLY> to apply the changes.

- ✓ For more information about the motion recording size and schedule, refer to "Motion Recording". (page 80)

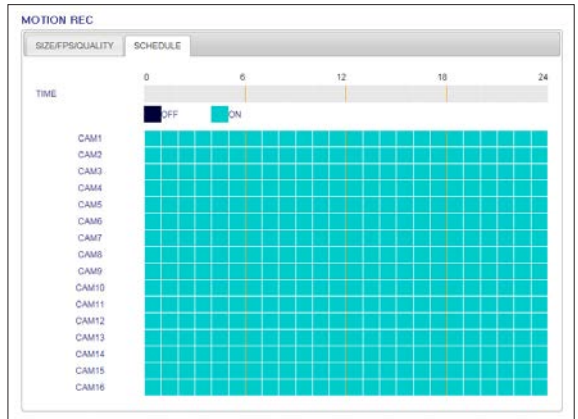

Web Viewer

Alarm Recording

Set the <SIZE/FPS/QUALITY/AUDIO> and the <SCHEDULE> to apply if an alarm event occurs. Click <▼> next to each item to display the list of values available.

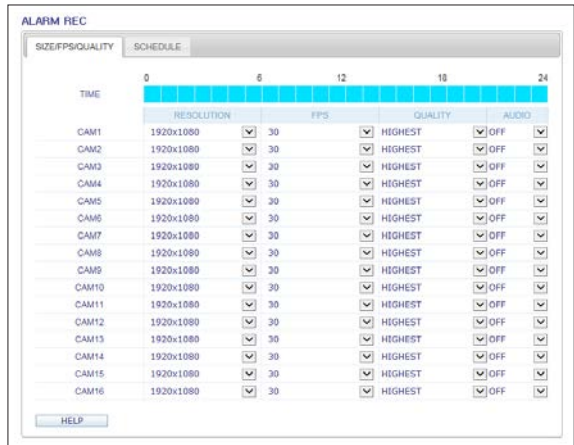

Complete setting the <SIZE/FPS/QUALITY/AUDIO> for the alarm recording as well as the <SCHEDULE>, and click <APPLY> to apply the changes.

- ✓ For more information about the alarm recording size and schedule, refer to "Alarm Recording". (page 80)

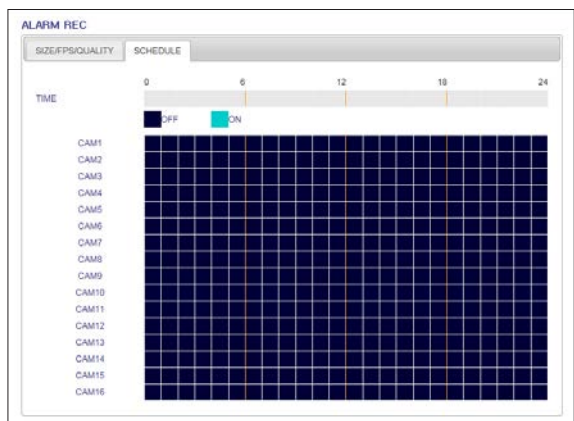

Panic Recording

From the <PANIC RECORD> menu, you can set the resolution, FPS, quality and audio settings to your preference.

Click <▼> next to each item to display the list of values available.

When you have completed the manual record settings, click <APPLY> to apply the changes.

- ✓ For more information about the manual record settings, refer to "Panic Recording". (page 81)

PANIC REC					
	RESOLUTION	FPS	QUALITY	AUDIO	
CAM1	1920x1080	30	HIGHEST	OFF	OFF
CAM2	1920x1080	30	HIGHEST	OFF	OFF
CAM3	1920x1080	30	HIGHEST	OFF	OFF
CAM4	1920x1080	30	HIGHEST	OFF	OFF
CAM5	1920x1080	30	HIGHEST	OFF	OFF
CAM6	1920x1080	30	HIGHEST	OFF	OFF
CAM7	1920x1080	30	HIGHEST	OFF	OFF
CAM8	1920x1080	30	HIGHEST	OFF	OFF
CAM9	1920x1080	30	HIGHEST	OFF	OFF
CAM10	1920x1080	30	HIGHEST	OFF	OFF
CAM11	1920x1080	30	HIGHEST	OFF	OFF
CAM12	1920x1080	30	HIGHEST	OFF	OFF
CAM13	1920x1080	30	HIGHEST	OFF	OFF
CAM14	1920x1080	30	HIGHEST	OFF	OFF
CAM15	1920x1080	30	HIGHEST	OFF	OFF
CAM16	1920x1080	30	HIGHEST	OFF	OFF

Network Streaming

You can specify the maximum size of network streaming and change the FPS.

Click <▼> next to each item to display the list of values available.

When done, click <APPLY> to apply the settings.

NETWORK STREAMING			
	MAX FPS	QUALITY	
CAM1	30	HIGHEST	▼
CAM2	30	HIGHEST	▼
CAM3	30	HIGHEST	▼
CAM4	30	HIGHEST	▼
CAM5	30	HIGHEST	▼
CAM6	30	HIGHEST	▼
CAM7	30	HIGHEST	▼
CAM8	30	HIGHEST	▼
CAM9	30	HIGHEST	▼
CAM10	30	HIGHEST	▼
CAM11	30	HIGHEST	▼
CAM12	30	HIGHEST	▼
CAM13	30	HIGHEST	▼
CAM14	30	HIGHEST	▼
CAM15	30	HIGHEST	▼
CAM16	30	HIGHEST	▼

ENABLE ADAPTIVE STREAMING CONTROL FOR REMOTE CLIENTS.

About

Click the <INFORMATION> tab to check the model name of the NVR as well as the web viewer version.

Web Viewer Information

NVR Model : 16CH / 480FPS

WEB Version : WEB_v2.7.3_1.0.0.63_140627

Mobile Viewer

GANZVIEW

You can use the smart viewer to monitor the network on a remote site and play the monitoring video anytime anywhere.

Ganzview specification

Minimum/ recommended specification

OS	Minimum specification	Recommended specification
Android Phone	Processor :800 MHz or higher	Processor : 1 GHz or higher
	Flash : 512 MB or higher	Flash : 512 MB
	RAM : 512 MB or higher	RAM : 512 MB
	SD Card : 4 GB or higher	SD Card : 16 GB or higher
	OS : 2.0 or higher	OS : 2.1 or higher
iPhone	iPhone 3G,	iPhone 3GS or higher
	iPod touch 3rd Generation	iPhone OS 3.2 or higher
	iPhone OS 3.1.3 or higher	

Using the Ganzview on iPhone

How to download the iPhone-dedicated application

From your iPhone, access the App Store.

Enter "Ganzview" in the search bar to find it before downloading. Install the application on your iPhone.

✓ The Ganzview supports the 1/4/9/16 split screen mode.

! With the Ganzview Lite, you cannot: check the log, control the PTZ operations or change the system settings.

To connect to NVR with Ganzview

1. Select and run the Ganzview.
2. Click < + > in the top right corner of the NVR List to select and add a site to the list.



3. Please enter a Name.
4. Provide the IP address, HTTP port number and RTSP port number.

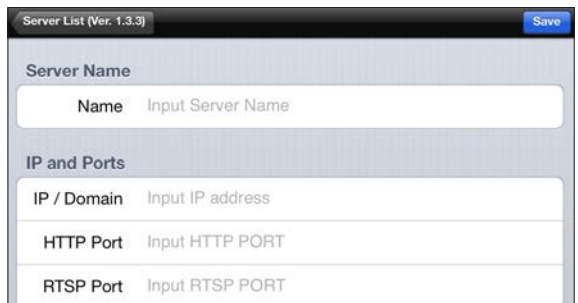

Mobile Viewer

- 5. Provide the access ID of the NVR as well as the password.
- 6. Select whether or not to save the ID and PW.
- 7. Click <Save>.



- 8. Select the site that you added in the NVR List.



- 9. Try to access the NVR.
If connected successfully, you will see the screen as shown.



Split Mode

1. Click any area on the screen.
The main menu appears at the bottom of the screen.

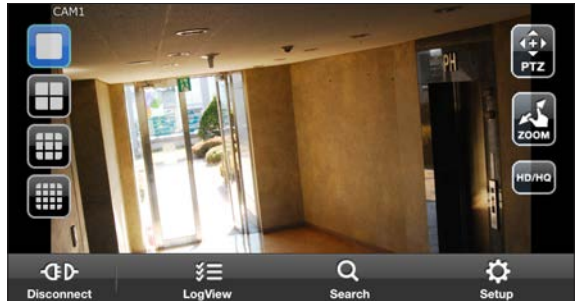

2. You can change your screen into 1-split mode by pressing the <[2x2 grid icon]> button; 4-split mode by pressing the <[2x2 grid icon]> button; and 9-split mode by pressing the <[3x3 grid icon]> button; and 16-split mode by pressing the <[4x4 grid icon]> button.



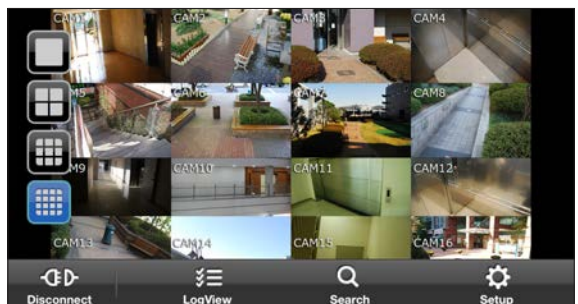
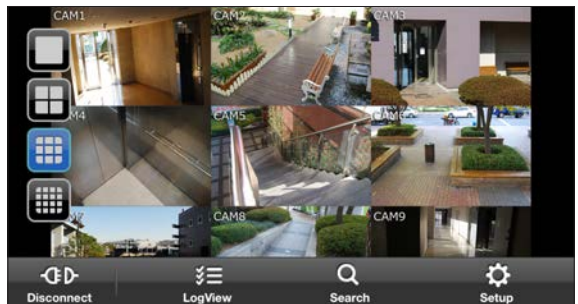
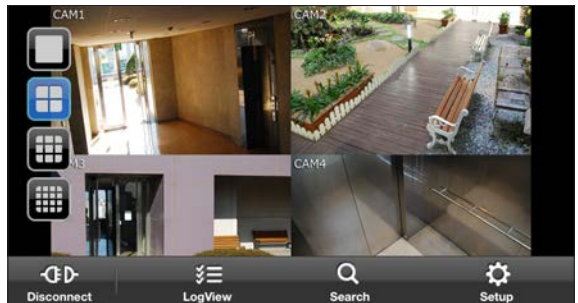



✓ Use the mouse to scroll the screen to the left or right to move to the next camera video screen.



Mobile Viewer

PTZ MODE

1. Press the  button in Main menu.

- ✓ You can control the focus by using the  button in your PTZ camera. Also, you can zoom in/out by using the .
- ✓ By using the  button, you can select the Auto Focus to adjust the focus automatically or the Default Focus to use the default lens value.
- ✓ You can rotate and control the PTZ camera horizontally and vertically by using the  button in screen.
- ✓  : Adjusting the Position Step changes how much the PTZ Camera moves when receiving a directional command. Low position step values mean smaller, more precise movements per directional movement click. High position step values mean greater, less precise movements per directional movement click.
- ✓ You can capture currently displayed screen by using the  button.

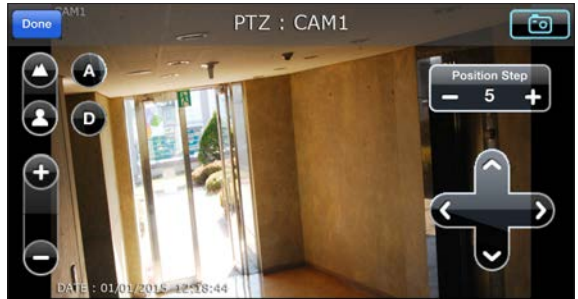

ZOOM MODE

1. You can touch the screen with your two fingers to zoom in/out the screen. After zooming in/out, click the  button to finish.

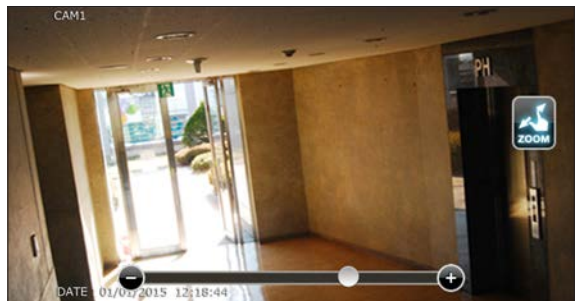

HD/HQ MODE

1. You can enjoy the HD/HQ screen by clicking the  button.

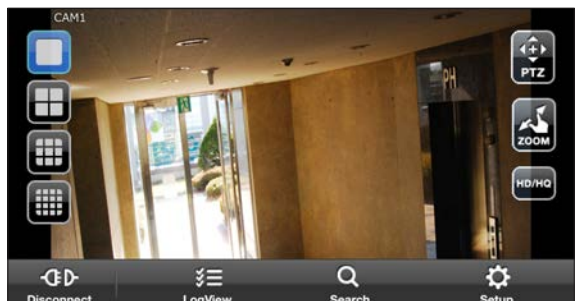

Using the Log View

- 1. From the main menu, click < [Menu Icon] >. You can check the log of the data stored.

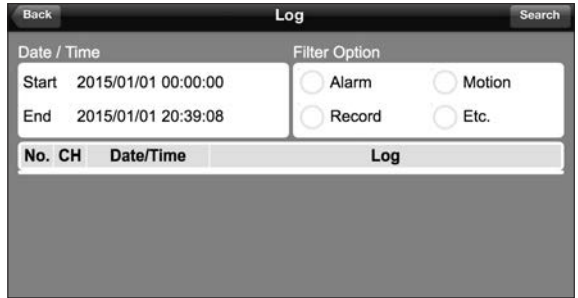

- 2. Select one from Alarm, Motion, Record, Etc. and click < [Search Icon] >. You will view the log of related items.



Mobile Viewer

Mobile Viewer

Using the Search function

1. From the main menu, click <  >. You can view the history of the data stored.
2. Select the date, time zone, and channel you want. You can select the start time by moving the time selection bar which is displayed vertically.



3. Click <  > to play the video recorded at the specified time.

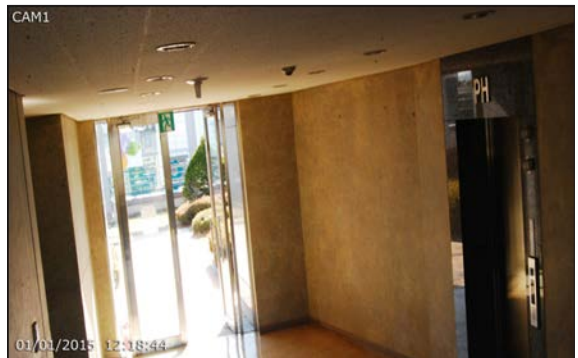

4. Click any area to display the play bar with which you can control the playing direction and speed of the video.

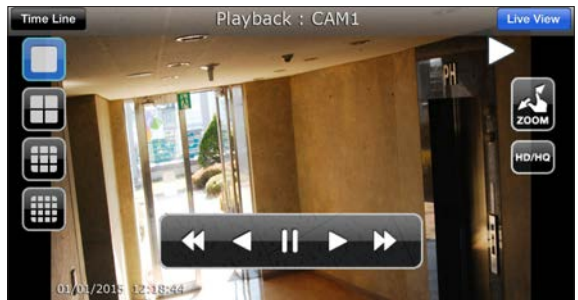

Using the Setup function

From the main menu, click <  >.
You will be connected to the web viewer site.

- ✓ For details about each displayed item, refer to "Setup".
(page 103)

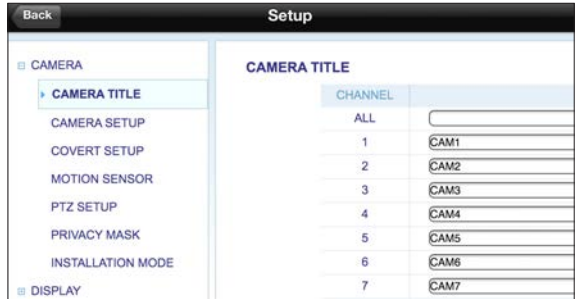

Mobile Viewer

Mobile Viewer

Using Ganzview with Android

How to download the Android-dedicated application

From your smart phone, access the Play Store.

Enter "Ganzview" in the search bar to find it before downloading. Install the application on your Smart Phone.

✓ The Ganzview supports the 1/4/9/16 split screen mode.

! With the Ganzview Lite, you cannot: check the log, control the PTZ operations or change the system settings.

To connect to NVR with Ganzview

1. Select and run the Ganzview.
2. Use the Add button to select and add a site to the list.



3. Please enter a Name.
4. Provide the IP address, HTTP port number and RTSP port number.
5. Provide the access ID of the NVR as well as the password.
6. Select whether or not to save the ID and PW.
7. Click <Save>.



- 8. Select the site that you added in the NVR List.
Press and hold the mouse button to display the pop-up window.

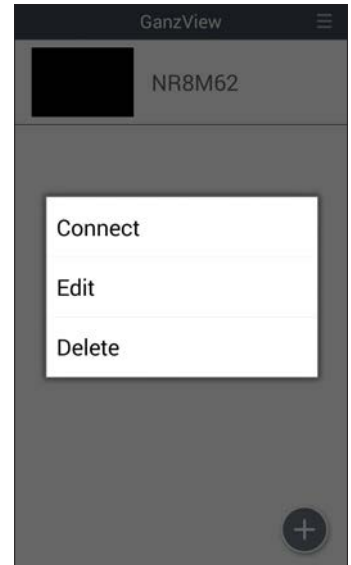

Mobile Viewer

- 9. Select <Connect> and try to access.
If connected successfully, you will see the screen as shown.

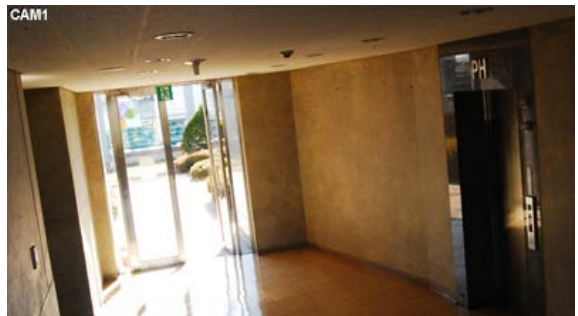

Split Mode

- 7. Click any area on the screen.
The main menu appears at the bottom of the screen.

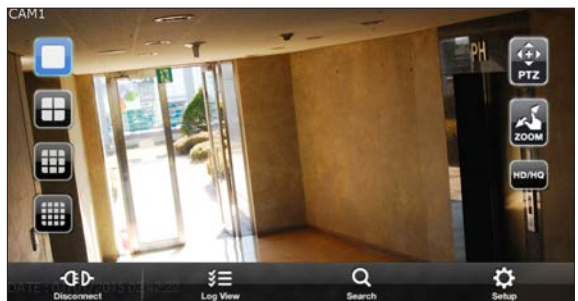

Mobile Viewer

- 2. You can change your screen into 1-split mode by pressing the < [] > button; 4-split mode by pressing the < [2x2] > button; and 9-split mode by pressing the < [3x3] > button; and 16-split mode by pressing the < [4x4] > button.

✓ Use the mouse to scroll the screen to the left or right to move to the next camera video screen.

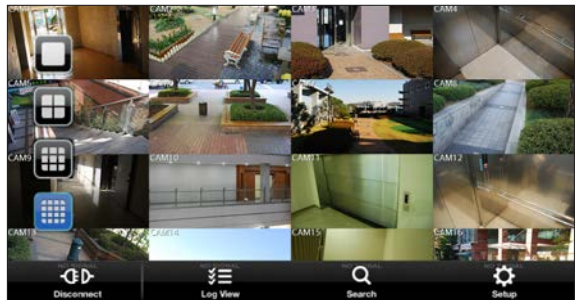
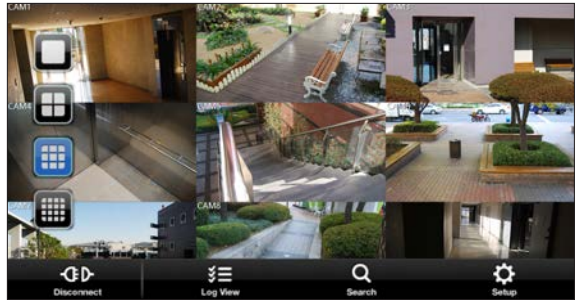
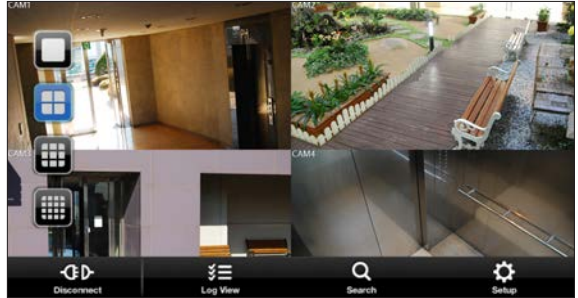

PTZ MODE

1. Press the  button in Main menu.

- ✓ You can control the focus by using the   button in your PTZ camera. Also, you can zoom in/out by using the  .
- ✓ By using the   button, you can select the Auto Focus to adjust the focus automatically or the Default Focus to use the default lens value.
- ✓ You can rotate and control the PTZ camera horizontally and vertically by using the     button in screen.
- ✓  : Adjusting the Position Step changes how much the PTZ Camera moves when receiving a directional command. Low position step values mean smaller, more precise movements per directional movement click. High position step values mean greater, less precise movements per directional movement click.
- ✓ You can capture currently displayed screen by using the  button.

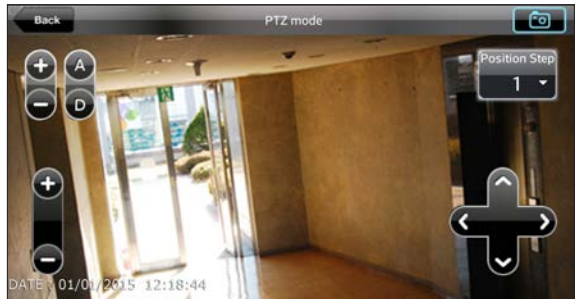

Mobile Viewer

ZOOM MODE

1. You can touch the screen with your two fingers to zoom in/out the screen. After zooming in/out, click the  button to finish.

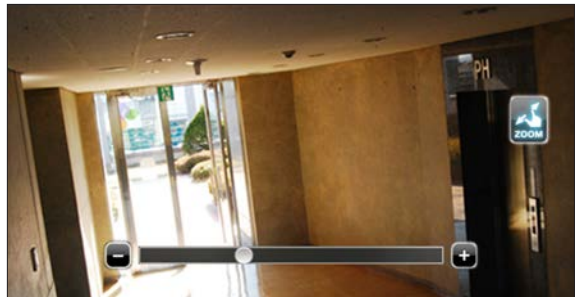

Mobile Viewer

HD/HQ MODE

1. You can touch the screen with your two fingers to zoom in/out the screen. After zooming in/out, click the  button to finish.

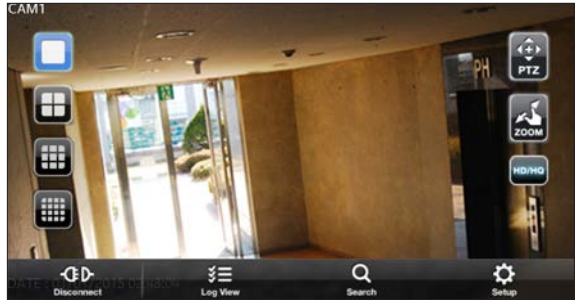

Using the Log View

1. From the main menu, click . You can check the log of the data stored.

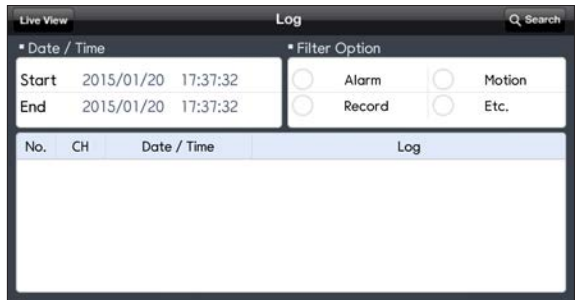

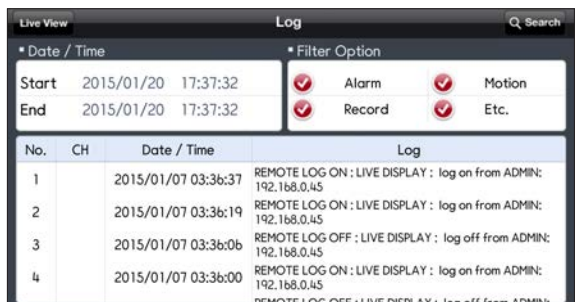

2. Select one from Alarm, Motion, Record, Etc. and click . You will view the log of related items.

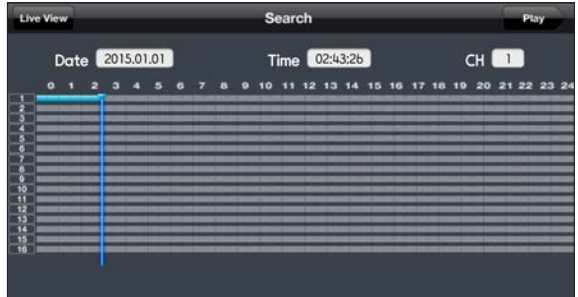

Using the Search function

1. From the main menu, click <  >. You can view the video of the recording data.
2. Select the date, time zone, and channel you want. You can select the start time by moving the time selection bar which is displayed vertically.



3. Click <  > to play the video recorded at the specified time.

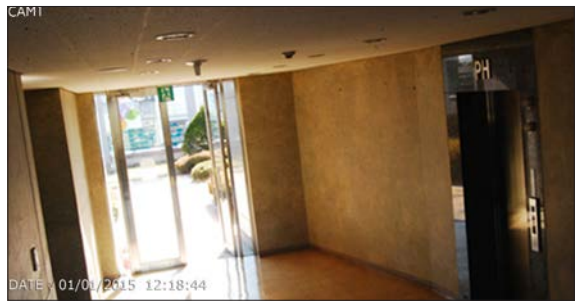

4. Click any area to display the play bar with which you can control the playing direction and speed of the video.

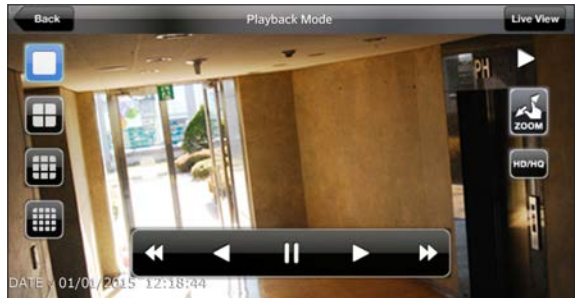

Mobile Viewer

Using the Setup function

From the main menu, click  >.
You will be connected to the web viewer site.

- ✓ For details about each displayed item, refer to "Setup".
(page 103)

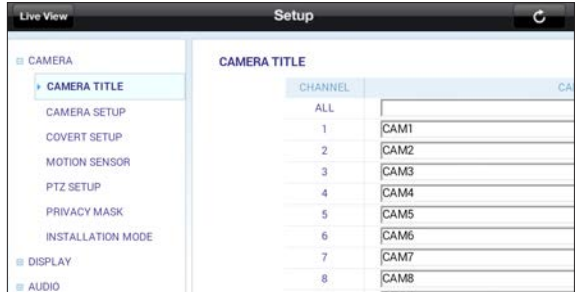

Archive Viewer

You can play the data archived in the NVR.
You can play the HDD data recorded by the NVR.

Getting started with the Backup Player

1. Connect the NVR to the backup USB storage device.
2. Open the folder saving the archived images.
3. Run the Backup Player.

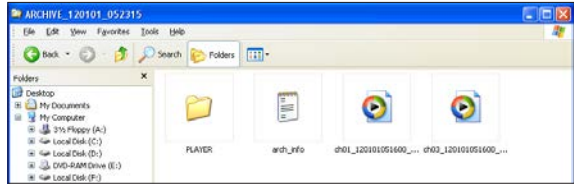

4. Click  in the bottom left corner to display the file browser. Select the archived file to play.

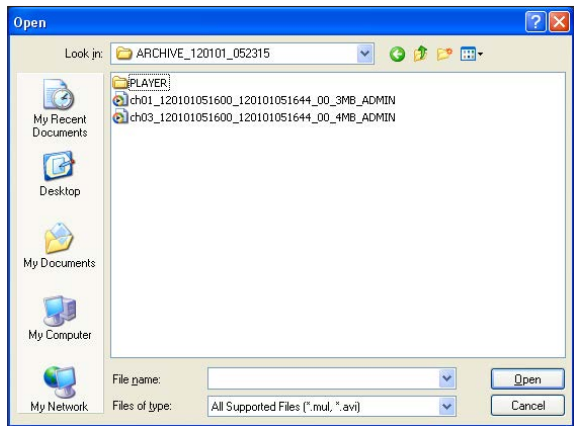
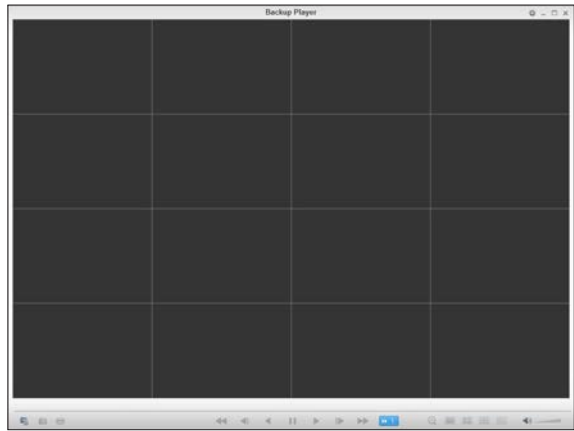

Archive Viewer

Archive Viewer

5. Check the integrity of the archived file.

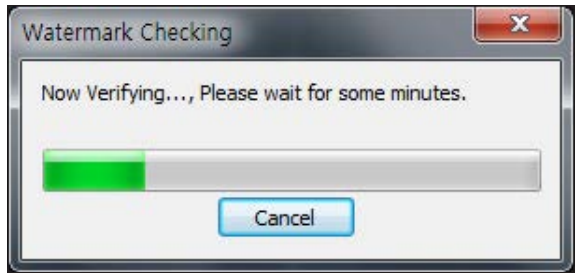
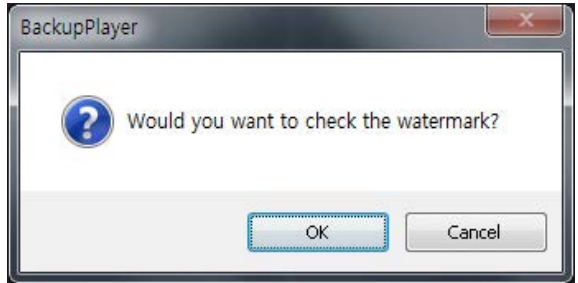

6. When done, the archived file will be played on the screen.



Backup Player At a Glance



No.	Item	Description
	Setup	Configure the environment settings.
❶	Minimize, Full Screen	You can minimize the Backup Player or expand it to the full screen.
	Close	Close the Backup Player.
❷	Channel Information	Show the channel information and the video resolution.
❸	Video Time	Display the time of the current video image.
❹	Play Time	Display the current playback time.
	File Search	Open the file that you backed up.
❺	Capture	Capture the current screen.
	Print	Print out the current screen.
❻	Playback Control	Control the playback direction and speed of the current video. For more information about how to use the playback control buttons, refer to "Using the play bar". (page 89)
❼	Zoom, Split Mode	Switch to Zoom, 1-/4-/9-/16-split screen mode.
❽	Audio Setting	Show the sound signal status and volume level.
❾	Play Bar	Display the current playback position in the video.

Archive Viewer

Video Capture

Click  to capture the current video image.

- **Selected Video** : Capture the actual frame of the current video.
- **Screen** : Capture the visible portion of the current video.
- **Format** : Select a saving format. (BMP, JPG, PNG)
- **Path** : Specify the saving path.

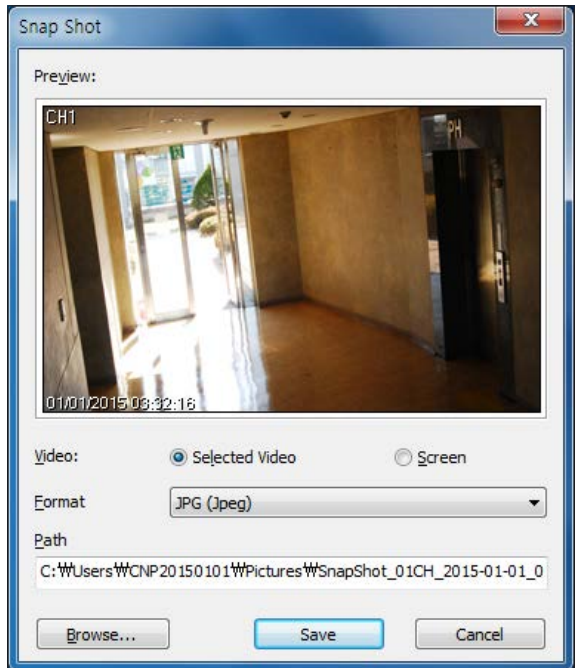

Print Out

Click  Button to print out the image.

When the "Print" window appears, check the preview and click <Print>.

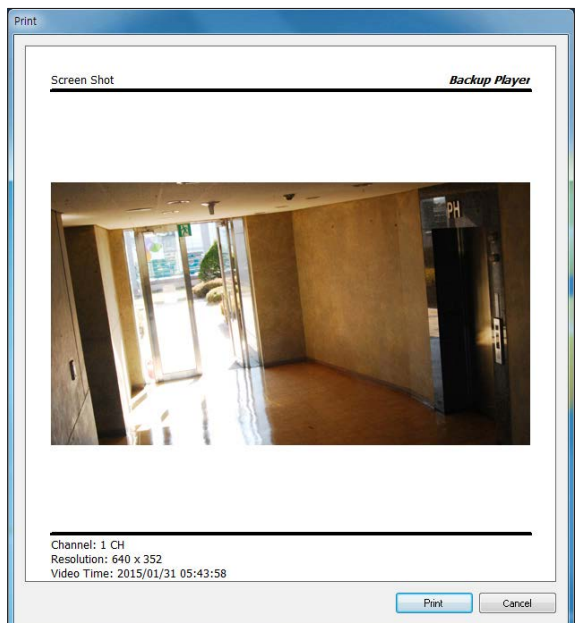

Settings

Click  to configure the Backup Player settings. You can check the version of the Backup Player.

- › Maintain image aspect ratio : Preserve the aspect ratio of the image. If you do not mark this option, the image will be adjusted to fit the screen.
- › I-frame play. : Plays i-frames (key frames) of the video.

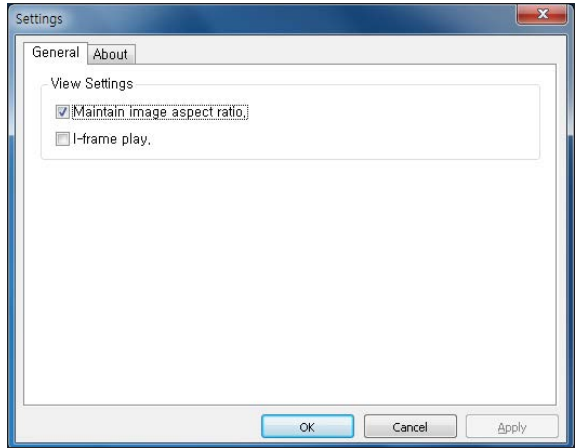

- › About : You can check the program information including the current version.

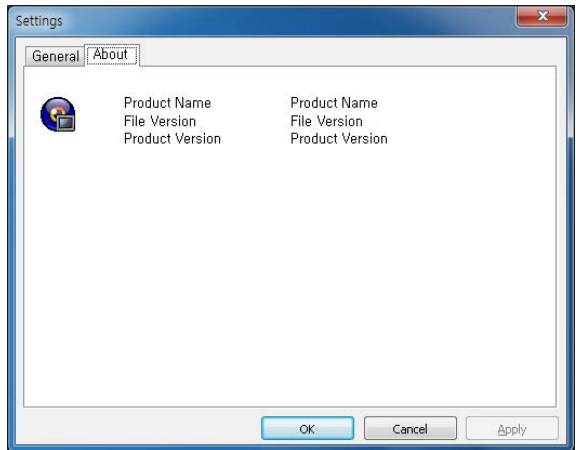

Appendix

Specification

Item	Details			Remarks
	4 CH	8 CH	16 CH	
VIDEO				
INPUT VIDEO	4 x IP Camera (Max HD1080p)	8 x IP Camera (Max HD1080p)	16 x IP Camera (Max HD1080p)	
# OF CHANNELS	4 CH	8 CH	16 CH	
MAIN MONITOR	VGA or HD Display	VGA or HD Display	VGA or HD Display	
MAIN MONITOR RESOLUTION	HD1080p/60Hz	HD1080p/60Hz	HD1080p/60Hz	
MOTION DETECTION	Yes (From IP Camera)	Yes (From IP Camera)	Yes (From IP Camera)	Depend on IP Camera
AUDIO				
INPUT AUDIO	4 CH (IP) + 1 CH (Internal)	8 CH (IP) + 1 CH (Internal)	16 CH (IP) + 1 CH (Internal)	Depend on IP Camera
OUTPUT AUDIO	4 CH (IP) + 1 CH (Internal)	8 CH (IP) + 1 CH (Internal)	16 CH (IP) + 1 CH (Internal)	Depend on IP Camera
CODEC	G.711	G.711	G.711	
RECORDING				
CODEC	H.264 (BP, MP, HP)	H.264 (BP, MP, HP)	H.264 (BP, MP, HP)	
REC.RATE	MAX. 30 FPS@1080p/CH	MAX. 30 FPS@1080p/CH	MAX. 30 FPS@1080p/CH	Depend on IP Camera
REC.RESOLUTION	MAX. HD 1080p	MAX. HD 1080p	MAX. HD 1080p	Depend on IP Camera
ALRM I/O				
ALARM INPUT	4 CH (IP) + 2 CH (Internal)	8 CH (IP) + 2 CH (Internal)	16 CH (IP) + 2 CH (Internal)	Depend on IP Camera
ALARM OUTPUT	4 CH (IP)+ 1 RELAY (Internal)	8 CH (IP)+ 1 RELAY (Internal)	16 CH (IP)+ 1 RELAY (Internal)	Depend on IP Camera
STORAGE				
INTERNAL HDD (SATA)	2 pcs	2 pcs	2 pcs	
EXTERNAL STORAGE	YES (eSATA)	YES (eSATA)	YES (eSATA)	

Item	Details			Remarks
	4 CH	8 CH	16 CH	
INTERFACES				
USB(USB2.0)	2 ports	2 ports	2 ports	
RS-485	1	1	1	
RS-232	1	1	1	
LAN	4 (IPCamera, PoE) + 1 (LAN) + 1 (WAN)	8 (IPCamera, PoE) + 1 (LAN) + 1 (WAN)	8 (IPCamera, PoE) + 1 (LAN) + 1 (WAN)	
REMOTE CONTROL	YES	YES	YES	
HUB				
Network			2GE + 8FE(PoE)	
Total PoE Power			72W	
NVR Management			ARM9 interior	
Adaptor			48V, 96W	
ETC				
WATCHDOG	YES	YES	YES	
COOLINGFAN	1 pc	1 pc	1 pc	
POWER				
POWER SUPPLY	12V adaptor (for System) + 48V adaptor (for PoE/ Camera)	12V adaptor (for System) + 48V adaptor (for PoE/ Camera)	12V adaptor (for System) + 48V adaptor (for PoE/ Camera)	
POWER CONSUMPTION	9W max. without HDD	11W max. without HDD	11W max. without HDD	
ENVIRONMENT				
HUMIDITY	10~90% NC	10~90% NC	10~90% NC	
TEMPERATURE	0°C ~ 40°C (32°F~104°F)	0°C ~ 40°C (32°F~104°F)	0°C ~ 40°C (32°F~104°F)	
CHASSIS				
DIMENSION	305 x 298 x 44	305 x 298 x 44	305 x 298 x 44	
WEIGHT				
CERTIFICATION				
	FCC, CE, C-tick	FCC, CE, C-tick	FCC, CE, C-tick	

Appendix

Compatible HDD Specifications

Maximum SATA Speed	<ul style="list-style-type: none"> • SATA1(1.5G) : Can be used • SATA2(3.0G) : Can be used • SATA3(6.0G) : Devices of backward compatibility to SATA2 (3.0G) can be used.
Maximum Start-up Current	12V, 2A (or lower)
Maximum Average Operation Power Consumption	7W (or lower)
Maximum R/W Latency	Latency (Read : 13ms / Write : 13ms) or smaller

- ✓ Use 3.5" HDD disks.
- ✓ Using HDD devices other than recommended specifications may cause serious problem.
- ✓ For further information of HDD specifications, refer to the applicable data sheet of the HDD manufacturer.

Product Overview

NVR-HUB (For 16channel NVR only)

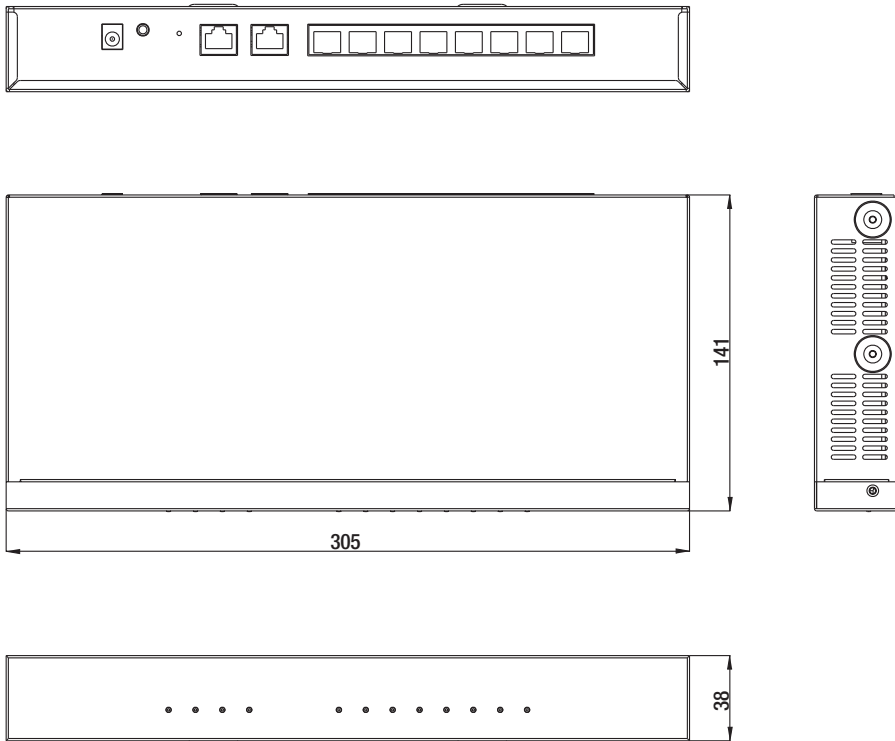

Appendix

Appendix

Troubleshooting (FAQ)

Problem	Action
The system does not operate at all with no active LED in the front panel.	<ul style="list-style-type: none"> • Make sure that the rear switch is turned on. • Make sure that the system gets supplied with power properly. • Check the input voltage.
The unit continuously reboots.	<ul style="list-style-type: none"> • Check if the system fan in a side panel of the unit or the CPU fan inside the unit works properly. If it fails, contact the retailer or the service center. • Disconnect the HDD cable and try to boot the system again. If the system reboots successfully, install a new HDD and check if the system make recording normally.
The front LED is lit, but nothing is displayed on the screen yet.	<ul style="list-style-type: none"> • Check if your monitor supports the 1080p 60Hz HDMI input. • Make sure that the monitor input source is set to HDMI. • If using the HDMI-to-DVI cable for the connection, ensure that the input source is set to DVI. • Make sure that the system gets supplied with power properly. • Check the input voltage.
The sides of the video image are displayed incomplete.	<ul style="list-style-type: none"> • If the monitor is over-scanning the video, the sides can be hidden. If this is the case, switch the display mode of the monitor to the 1:1 pixel matching mode. Then, you will view the video in full screen. • The 1:1 pixel matching is referred to differently depending on the monitor manufacturer (for example, "JUST SCAN" for Samsung, "ZERO OVERSCAN" for LG). For details, refer to the user manual of the monitor.
The camera is connected but no image is displayed.	<ul style="list-style-type: none"> • Make sure that the IP camera is compatible with the NVR. For the compatibility of the IP cameras, contact the retailer. • Ensure that a 48V PoE adaptor is connected to the rear of the unit. • Check if the camera supports PoE. If your camera is not compatible with the PoE protocols, use a separate power source for the camera. • Check if the total power consumption of the cameras exceeds the rated capacity of the 48V PoE adaptor. If the total exceeds the rated capacity, the unit may not play the video or it may fail to operate. If this is the case, use a separate power source for the camera.
It fails to connect to the web or mobile application.	<ul style="list-style-type: none"> • Check if the network cable is properly connected to the WAN(UP Link) port of the unit. • You must have set the port forwarding if using a router. • If you cannot get access with the DDNS address, use the IP address of the NVR instead. If the NVR is connected to the router, use the IP address of the NVR. You can check the IP address of the router in <NETWORK STATUS> - <EXTERNAL IP ADDRESS>.
I can access the web or mobile application but still no video image is displayed.	<ul style="list-style-type: none"> • You must have set the port forwarding if using a router. • This may happen when the communications provider or network administrator has blocked the service port of the NVR. Change the RTSP port and HTTP port numbers to different ones and set the port forwarding again. • Try to access the web or mobile application using the new port numbers.

Open Source License Report on the Product

The software included in this product contains copyrighted software that is licensed under the GPL/LGPL.

- GPL Software : linux kernel, busybox, cdrtools, dvd+rw-tools, smartctl, uboot, bash, udev, sysklogd
- LGPL Software : glibc, vmstat, glib, gtk, libESMTP, iconv, gstreamer, pango,
- OpenSSL License : OpenSSL

GNU GENERAL PUBLIC LICENSE

Version 2, June 1991

Copyright (C) 1989, 1991 Free Software Foundation, Inc.

51 Franklin Street, Fifth Floor, Boston, MA 02110-1301, USA

Everyone is permitted to copy and distribute verbatim copies of this license document, but changing it is not allowed.

Preamble

The licenses for most software are designed to take away your freedom to share and change it. By contrast, the GNU General Public License is intended to guarantee your freedom to share and change free software to make sure the software is free for all its users. This General Public License applies to most of the Free Software Foundation's software and to any other program whose authors commit to using it. (Some other Free Software Foundation software is covered by the GNU Lesser General Public License instead.) You can apply it to your programs, too.

When we speak of free software, we are referring to freedom, not price. Our General Public Licenses are designed to make sure that you have the freedom to distribute copies of free software (and charge for this service if you wish), that you receive source code or can get it if you want it, that you can change the software or use pieces of it in new free programs; and that you know you can do these things.

To protect your rights, we need to make restrictions that forbid anyone to deny you these rights or to ask you to surrender the rights. These restrictions translate to certain responsibilities for you if you distribute copies of the software, or if you modify it.

For example, if you distribute copies of such a program, whether gratis or for a fee, you must give the recipients all the rights that you have. You must make sure that they, too, receive or can get the source code. And you must show them these terms so they know their rights.

We protect your rights with two steps:

(1) copyright the software, and (2) offer you this license which gives you legal permission to copy, distribute and/or modify the software.

Also, for each author's protection and ours, we want to make certain that everyone understands that there is no warranty for this free software. If the software is modified by someone else and passed on, we want its recipients to know that what they have is not the original, so that any problems introduced by others will not reflect on the original authors' reputations.

Finally, any free program is threatened constantly by software patents. We wish to avoid the danger that redistributors of a free program will individually obtain patent licenses, in effect making the program proprietary. To prevent this, we have made it clear that any patent must be licensed for everyone's free use or not licensed at all. The precise terms and conditions for copying, distribution and modification follow.

TERMS AND CONDITIONS FOR COPYING, DISTRIBUTION AND MODIFICATION

Version 2, June 1991

Copyright (C) 1989, 1991 Free Software Foundation, Inc.

51 Franklin S

0. This License applies to any program or other work which contains a notice placed by the copyright holder saying it may be distributed under the terms of this General Public License. The "Program", below, refers to any such program or work, and a "work based on the Program" means either the Program or any derivative work under copyright law: that is to say, a work containing the Program or a portion of it, either verbatim or with modifications and/or translated into another language. (Hereinafter, translation is included without limitation in the term "modification".) Each licensee is addressed as "you".

Activities other than copying, distribution and modification are not covered by this License; they are outside its scope. The act of running the Program is not restricted, and the output from the Program is covered only if its contents constitute a work based on the Program (independent of having been made by running the Program). Whether that is true depends on what the Program does.

1. You may copy and distribute verbatim copies of the Program's source code as you receive it, in any medium, provided that you conspicuously and appropriately publish on each copy an appropriate copyright notice and disclaimer of warranty; keep intact all the notices that refer to this License and to the absence of any warranty; and give any other recipients of the Program a copy of this License along with the Program.

You may charge a fee for the physical act of transferring a copy, and you may at your option offer warranty protection in exchange for a fee.

2. You may modify your copy or copies of the Program or any portion of it, thus forming a work based on the Program, and copy and distribute such modifications or work under the terms of Section 1 above, provided that you also meet all of these conditions:

- a) You must cause the modified files to carry prominent notices stating that you changed the files and the date of any change.
- b) You must cause any work that you distribute or publish, that in whole or in part contains or is derived from the Program or any part thereof, to be licensed as a whole at no charge to all third parties under the terms of this License.
- c) If the modified program normally reads commands interactively when run, you must cause it, when started running for such interactive use in the most ordinary way, to print or display an announcement including an appropriate copyright notice and a notice that there is no warranty (or else, saying that you provide a warranty) and that users may redistribute the program under these conditions, and telling the user how to view a copy of this License. (Exception: if the Program itself is interactive but does not normally print such an announcement, your work based on the Program is not required to print an announcement.)

These requirements apply to the modified work as a whole. If identifiable sections of that work are not derived from the Program, and can be reasonably considered independent and separate works in themselves, then this License, and its terms, do not apply to those sections when you distribute them as separate works. But when you distribute the same sections as part of a whole which is a work based on the Program, the distribution of the whole must be on the terms of this License, whose permissions for other licensees extend to the entire whole, and thus to each and every part regardless of who wrote it.

Thus, it is not the intent of this section to claim rights or contest your rights to work written entirely by you; rather, the intent is to exercise the right to control the distribution of derivative or collective works based on the Program.

In addition, mere aggregation of another work not based on the Program with the Program (or with a work based on the Program) on a volume of a storage or distribution medium does not bring the other work under the scope of this License.

3. You may copy and distribute the Program (or a work based on it, under Section 2) in object code or executable form under the terms of Sections 1 and 2 above provided that you also do one of the following:

- a) Accompany it with the complete corresponding machine-readable source code, which must be distributed under the terms of Sections 1 and 2 above on a medium customarily used for software interchange; or,
- b) Accompany it with a written offer, valid for at least three years, to give any third party, for a charge no more than your cost of physically performing source distribution, a complete machine-readable copy of the corresponding source code, to be distributed under the terms of Sections 1 and 2 above on a medium customarily used for software interchange; or,

- c) Accompany it with the information you received as to the offer to distribute corresponding source code. (This alternative is allowed only for noncommercial distribution and only if you received the program in object code or executable form with such an offer, in accord with Subsection b above.)

The source code for a work means the preferred form of the work for making modifications to it. For an executable work, complete source code means all the source code for all modules it contains, plus any associated interface definition files, plus the scripts used to control compilation and installation of the executable. However, as a special exception, the source code distributed need not include anything that is normally distributed (in either source or binary form) with the major components (compiler, kernel, and so on) of the operating system on which the executable runs, unless that component itself accompanies the executable.

If distribution of executable or object code is made by offering access to copy from a designated place, then offering equivalent access to copy the source code from the same place counts as distribution of the source code, even though third parties are not compelled to copy the source along with the object code.

4. You may not copy, modify, sublicense, or distribute the Program except as expressly provided under this License. Any attempt otherwise to copy, modify, sublicense or distribute the Program is void, and will automatically terminate your rights under this License. However, parties who have received copies, or rights, from you under this License will not have their licenses terminated so long as such parties remain in full compliance.

5. You are not required to accept this License, since you have not signed it. However, nothing else grants you permission to modify or distribute the Program or its derivative works. These actions are prohibited by law if you do not accept this License. Therefore, by modifying or distributing the Program (or any work based on the Program), you indicate your acceptance of this License to do so, and all its terms and conditions for copying, distributing or modifying the Program or works based on it.

6. Each time you redistribute the Program (or any work based on the Program), the recipient automatically receives a license from the original licensor to copy, distribute or modify the Program subject to these terms and conditions. You may not impose any further restrictions on the recipients' exercise of the rights granted herein. You are not responsible for enforcing compliance by third parties to this License.

7. If, as a consequence of a court judgment or allegation of patent infringement or for any other reason (not limited to patent issues), conditions are imposed on you (whether by court order, agreement or otherwise) that contradict the conditions of this License, they do not excuse you from the conditions of this License. If you cannot distribute so as to satisfy simultaneously your obligations under this License and any other pertinent obligations, then as a consequence you may not distribute the Program at all. For example, if a patent license would not permit royalty-free redistribution of the Program by all those who receive copies directly or indirectly through you, then the only way you could satisfy both it and this License would be to refrain entirely from distribution of the Program.

If any portion of this section is held invalid or unenforceable under any particular circumstance, the balance of the section is intended to apply and the section as a whole is intended to apply in other circumstances.

It is not the purpose of this section to induce you to infringe any patents or other property right claims or to contest validity of any such claims; this section has the sole purpose of protecting the integrity of the free software distribution system, which is implemented by public license practices. Many people have made generous contributions to the wide range of software distributed through that system in reliance on consistent application of that system; it is up to the author/donor to decide if he or she is willing to distribute software through any other system and a licensee cannot impose that choice.

This section is intended to make thoroughly clear what is believed to be a consequence of the rest of this License.

8. If the distribution and/or use of the Program is restricted in certain countries either by patents or by copyrighted interfaces, the original copyright holder who places the Program under this License may add an explicit geographical distribution limitation excluding those countries, so that distribution is permitted only in or among countries not thus excluded. In such case, this License incorporates the limitation as if written in the body of this License.

9. The Free Software Foundation may publish revised and/or new versions of the General Public License from time to time. Such new versions will be similar in spirit to the present version, but may differ in detail to address new problems or concerns.

Each version is given a distinguishing version number. If the Program specifies a version number of this License which applies to it and "any later version", you have the option of following the terms and conditions either of that version or of any later version published by the Free Software Foundation. If the Program does not specify a version number of this License, you may choose any version ever published by the Free Software Foundation.

10. If you wish to incorporate parts of the Program into other free programs whose distribution conditions are different, write to the author to ask for permission. For software which is copyrighted by the Free Software Foundation, write to the Free Software Foundation; we sometimes make exceptions for this. Our decision will be guided by the two goals of preserving the free status of all derivatives of our free software and of promoting the sharing and reuse of software generally.

NO WARRANTY

11. BECAUSE THE PROGRAM IS LICENSED FREE OF CHARGE, THERE IS NO WARRANTY FOR THE PROGRAM, TO THE EXTENT PERMITTED BY APPLICABLE LAW. EXCEPT WHEN OTHERWISE STATED IN WRITING THE COPYRIGHT HOLDERS AND/OR OTHER PARTIES PROVIDE THE PROGRAM "AS IS" WITHOUT WARRANTY OF ANY KIND, EITHER EXPRESSED OR IMPLIED, INCLUDING, BUT NOT LIMITED TO, THE IMPLIED WARRANTIES OF MERCHANTABILITY AND FITNESS FOR A PARTICULAR PURPOSE. THE ENTIRE RISK AS TO THE QUALITY AND PERFORMANCE OF THE PROGRAM IS WITH YOU. SHOULD THE PROGRAM PROVE DEFECTIVE, YOU ASSUME THE COST OF ALL NECESSARY SERVICING, REPAIR OR CORRECTION.

12. IN NO EVENT UNLESS REQUIRED BY APPLICABLE LAW OR AGREED TO IN WRITING WILL ANY COPYRIGHT HOLDER, OR ANY OTHER PARTY WHO MAY MODIFY AND/OR REDISTRIBUTE THE PROGRAM AS PERMITTED ABOVE, BE LIABLE TO YOU FOR DAMAGES, INCLUDING ANY GENERAL, SPECIAL, INCIDENTAL OR CONSEQUENTIAL DAMAGES ARISING OUT OF THE USE OR INABILITY TO USE THE PROGRAM (INCLUDING BUT NOT LIMITED TO LOSS OF DATA OR DATA BEING RENDERED INACCURATE OR LOSSES SUSTAINED BY YOU OR THIRD PARTIES OR A FAILURE OF THE PROGRAM TO OPERATE WITH ANY OTHER PROGRAMS), EVEN IF SUCH HOLDER OR OTHER PARTY HAS BEEN ADVISED OF THE POSSIBILITY OF SUCH DAMAGES.

END OF TERMS AND CONDITIONS

How to Apply These Terms to Your New Programs

If you develop a new program, and you want it to be of the greatest possible use to the public, the best way to achieve this is to make it free software which everyone can redistribute and change under these terms.

To do so, attach the following notices to the program. It is safest to attach them to the start of each source file to most effectively convey the exclusion of warranty; and each file should have at least the "copyright" line and a pointer to where the full notice is found.

one line to give the program's name and an idea of what it does.

Copyright (C) yyyy name of author

This program is free software; you can redistribute it and/or modify it under the terms of the GNU General Public License as published by the Free Software Foundation; either version 2 of the License, or (at your option) any later version.

This program is distributed in the hope that it will be useful, but WITHOUT ANY WARRANTY; without even the implied warranty of MERCHANTABILITY or FITNESS FOR A PARTICULAR PURPOSE. See the GNU General Public License for more details.

You should have received a copy of the GNU General Public License along with this program; if not, write to the Free Software Foundation, Inc., 51 Franklin Street, Fifth Floor, Boston, MA 02110-1301, USA.

Also add information on how to contact you by electronic and paper mail. If the program is interactive, make it output a short notice like this when it starts in an interactive mode:

Gnomovision version 69, Copyright (C) year name of author Gnomovision comes with ABSOLUTELY NO WARRANTY; for details type 'show w'. This is free software, and you are welcome to redistribute it under certain conditions; type 'show c' for details.

The hypothetical commands 'show w' and 'show c' should show the appropriate parts of the General Public License. Of course, the commands you use may be called something other than 'show w' and 'show c'; they could even be mouse-clicks or menu items--whatever suits your program.

You should also get your employer (if you work as a programmer) or your school, if any, to sign a "copyright disclaimer" for the program, if necessary. Here is a sample; alter the names:

Yoyodyne, Inc., hereby disclaims all copyright interest in the program 'Gnomovision' (which makes passes at compilers) written by James Hacker.

signature of Ty Coon, 1 April 1989 Ty Coon, President of Vice This General Public License does not permit incorporating your program into proprietary programs. If your program is a subroutine library, you may consider it more useful to permit linking proprietary applications with the library. If this is what you want to do, use the GNU Lesser General Public License instead of this License.

GNU GENERAL PUBLIC LICENSE

Version 3, 29 June 2007

Copyright © 2007 Free Software Foundation, Inc. <<http://fsf.org/>>

Everyone is permitted to copy and distribute verbatim copies of this license document, but changing it is not allowed.

Preamble

The GNU General Public License is a free, copyleft license for software and other kinds of works.

The licenses for most software and other practical works are designed to take away your freedom to share and change the works. By contrast, the GNU General Public License is intended to guarantee your freedom to share and change all versions of a program--to make sure it remains free software for all its users. We, the Free Software Foundation, use the GNU General Public License for most of our software; it applies also to any other work released this way by its authors. You can apply it to your programs, too.

When we speak of free software, we are referring to freedom, not price. Our General Public Licenses are designed to make sure that you have the freedom to distribute copies of free software (and charge for them if you wish), that you receive source code or can get it if you want it, that you can change the software or use pieces of it in new free programs, and that you know you can do these things.

To protect your rights, we need to prevent others from denying you these rights or asking you to surrender the rights. Therefore, you have certain responsibilities if you distribute copies of the software, or if you modify it: responsibilities to respect the freedom of others.

For example, if you distribute copies of such a program, whether gratis or for a fee, you must pass on to the recipients the same freedoms that you received. You must make sure that they, too, receive or can get the source code. And you must show them these terms so they know their rights.

Developers that use the GNU GPL protect your rights with two steps: (1) assert copyright on the software, and (2) offer you this License giving you legal permission to copy, distribute and/or modify it.

For the developers' and authors' protection, the GPL clearly explains that there is no warranty for this free software. For both users' and authors' sake, the GPL requires that modified versions be marked as changed, so that their problems will not be attributed erroneously to authors of previous versions.

Some devices are designed to deny users access to install or run modified versions of the software inside them, although the manufacturer can do so. This is fundamentally incompatible with the aim of protecting users' freedom to change the software. The systematic pattern of such abuse occurs in the area of products for individuals to use, which is precisely where it is most unacceptable. Therefore, we have designed this version of the GPL to prohibit the practice for those products. If such problems arise substantially in other domains, we stand ready to extend this provision to those domains in future versions of the GPL, as needed to protect the freedom of users.

Finally, every program is threatened constantly by software patents. States should not allow patents to restrict development and use of software on general-purpose computers, but in those that do, we wish to avoid the special danger that patents applied to a free program could make it effectively proprietary. To prevent this, the GPL assures that patents cannot be used to render the program non-free.

The precise terms and conditions for copying, distribution and modification follow.

TERMS AND CONDITIONS

0. Definitions.

"This License" refers to version 3 of the GNU General Public License.

"Copyright" also means copyright-like laws that apply to other kinds of works, such as semiconductor masks.

"The Program" refers to any copyrightable work licensed under this License. Each licensee is addressed as "you". "Licensees" and "recipients" may be individuals or organizations.

To "modify" a work means to copy from or adapt all or part of the work in a fashion requiring copyright permission, other than the making of an exact copy. The resulting work is called a "modified version" of the earlier work or a work "based on" the earlier work.

A "covered work" means either the unmodified Program or a work based on the Program.

To "propagate" a work means to do anything with it that, without permission, would make you directly or secondarily liable for infringement under applicable copyright law, except executing it on a computer or modifying a private copy. Propagation includes copying, distribution (with or without modification), making available to the public, and in some countries other activities as well.

To "convey" a work means any kind of propagation that enables other parties to make or receive copies. Mere interaction with a user through a computer network, with no transfer of a copy, is not conveying.

An interactive user interface displays "Appropriate Legal Notices" to the extent that it includes a convenient and prominently visible feature that (1) displays an appropriate copyright notice, and (2) tells the user that there is no warranty for the work (except to the extent that warranties are provided), that licensees may convey the work under this License, and how to view a copy of this License. If the interface presents a list of user commands or options, such as a menu, a prominent item in the list meets this criterion.

1. Source Code.

The "source code" for a work means the preferred form of the work for making modifications to it. "Object code" means any non-source form of a work.

A "Standard Interface" means an interface that either is an official standard defined by a recognized standards body, or, in the case of interfaces specified for a particular programming language, one that is widely used among developers working in that language.

The "System Libraries" of an executable work include anything, other than the work as a whole, that (a) is included in the normal form of packaging a Major Component, but which is not part of that Major Component, and (b) serves only to enable use of the work with that Major Component, or to implement a Standard Interface for which an implementation is available to the public in source code form. A "Major Component", in this context, means a major essential component (kernel, window system, and so on) of the specific operating system (if any) on which the executable work runs, or a compiler used to produce the work, or an object code interpreter used to run it.

The "Corresponding Source" for a work in object code form means all the source code needed to generate, install, and (for an executable work) run the object code and to modify the work, including scripts to control those activities. However, it does not include the work's System Libraries, or general-purpose tools or generally available free programs which are used unmodified in performing those activities but which are not part of the work. For example, Corresponding Source includes interface definition files associated with source files for the work, and the source code for shared libraries and dynamically linked subprograms that the work is specifically designed to require, such as by intimate data communication or control flow between those subprograms and other parts of the work.

The Corresponding Source need not include anything that users can regenerate automatically from other parts of the Corresponding Source.

The Corresponding Source for a work in source code form is that same work.

2. Basic Permissions.

All rights granted under this License are granted for the term of copyright on the Program, and are irrevocable provided the stated conditions are met. This License explicitly affirms your unlimited permission to run the unmodified Program. The output from running a covered work is covered by this License only if the output, given its content, constitutes a covered work. This License acknowledges your rights of fair use or other equivalent, as provided by copyright law.

You may make, run and propagate covered works that you do not convey, without conditions so long as your license otherwise remains in force. You may convey covered works to others for the sole purpose of having them make modifications exclusively for you, or provide you with facilities for running those works, provided that you comply with the terms of this License in conveying all material for which you do not control copyright. Those thus making or running the covered works for you must do so exclusively on your behalf, under your direction and control, on terms that prohibit them from making any copies of your copyrighted material outside their relationship with you.

Conveying under any other circumstances is permitted solely under the conditions stated below. Sublicensing is not allowed; section 10 makes it unnecessary.

3. Protecting Users' Legal Rights From Anti-Circumvention Law.

No covered work shall be deemed part of an effective technological measure under any applicable law fulfilling obligations under article 11 of the WIPO copyright treaty adopted on 20 December 1996, or similar laws prohibiting or restricting circumvention of such measures.

When you convey a covered work, you waive any legal power to forbid circumvention of technological measures to the extent such circumvention is effected by exercising rights under this License with respect to the covered work, and you disclaim any intention to limit operation or modification of the work as a means of enforcing, against the work's users, your or third parties' legal rights to forbid circumvention of technological measures.

4. Conveying Verbatim Copies.

You may convey verbatim copies of the Program's source code as you receive it, in any medium, provided that you conspicuously and appropriately publish on each copy an appropriate copyright notice; keep intact all notices stating that this License and any non-permissive terms added in accord with section 7 apply to the code; keep intact all notices of the absence of any warranty; and give all recipients a copy of this License along with the Program.

You may charge any price or no price for each copy that you convey, and you may offer support or warranty protection for a fee.

5. Conveying Modified Source Versions.

You may convey a work based on the Program, or the modifications to produce it from the Program, in the form of source code under the terms of section 4, provided that you also meet all of these conditions:

- a) The work must carry prominent notices stating that you modified it, and giving a relevant date.
- b) The work must carry prominent notices stating that it is released under this License and any conditions added under section 7. This requirement modifies the requirement in section 4 to "keep intact all notices".
- c) You must license the entire work, as a whole, under this License to anyone who comes into possession of a copy. This License will therefore apply, along with any applicable section 7 additional terms, to the whole of the work, and all its parts, regardless of how they are packaged. This License gives no permission to license the work in any other way, but it does not invalidate such permission if you have separately received it.
- d) If the work has interactive user interfaces, each must display Appropriate Legal Notices; however, if the Program has interactive interfaces that do not display Appropriate Legal Notices, your work need not make them do so.

A compilation of a covered work with other separate and independent works, which are not by their nature extensions of the covered work, and which are not combined with it such as to form a larger program, in or on a volume of a storage or distribution medium, is called an "aggregate" if the compilation and its resulting copyright are not used to limit the access or legal rights of the compilation's users beyond what the individual works permit. Inclusion of a covered work in an aggregate does not cause this License to apply to the other parts of the aggregate.

6. Conveying Non-Source Forms.

You may convey a covered work in object code form under the terms of sections 4 and 5, provided that you also convey the machine-readable Corresponding Source under the terms of this License, in one of these ways:

- a) Convey the object code in, or embodied in, a physical product (including a physical distribution medium), accompanied by the Corresponding Source fixed on a durable physical medium customarily used for software interchange.
- b) Convey the object code in, or embodied in, a physical product (including a physical distribution medium), accompanied by a written offer, valid for at least three years and valid for as long as you offer spare parts or customer support for that product model, to give anyone who possesses the object code either (1) a copy of the Corresponding Source for all the software in the product that is covered by this License, on a durable physical medium customarily used for software interchange, for a price no more than your reasonable cost of physically performing this conveying of source, or (2) access to copy the Corresponding Source from a network server at no charge.
- c) Convey individual copies of the object code with a copy of the written offer to provide the Corresponding Source. This alternative is allowed only occasionally and noncommercially, and only if you received the object code with such an offer, in accord with subsection 6b.

- d) Convey the object code by offering access from a designated place (gratis or for a charge), and offer equivalent access to the Corresponding Source in the same way through the same place at no further charge. You need not require recipients to copy the Corresponding Source along with the object code. If the place to copy the object code is a network server, the Corresponding Source may be on a different server (operated by you or a third party) that supports equivalent copying facilities, provided you maintain clear directions next to the object code saying where to find the Corresponding Source. Regardless of what server hosts the Corresponding Source, you remain obligated to ensure that it is available for as long as needed to satisfy these requirements.
- e) Convey the object code using peer-to-peer transmission, provided you inform other peers where the object code and Corresponding Source of the work are being offered to the general public at no charge under subsection 6d.

A separable portion of the object code, whose source code is excluded from the Corresponding Source as a System Library, need not be included in conveying the object code work.

A "User Product" is either (1) a "consumer product", which means any tangible personal property which is normally used for personal, family, or household purposes, or (2) anything designed or sold for incorporation into a dwelling. In determining whether a product is a consumer product, doubtful cases shall be resolved in favor of coverage. For a particular product received by a particular user, "normally used" refers to a typical or common use of that class of product, regardless of the status of the particular user or of the way in which the particular user actually uses, or expects or is expected to use, the product. A product is a consumer product regardless of whether the product has substantial commercial, industrial or non-consumer uses, unless such uses represent the only significant mode of use of the product.

"Installation Information" for a User Product means any methods, procedures, authorization keys, or other information required to install and execute modified versions of a covered work in that User Product from a modified version of its Corresponding Source. The information must suffice to ensure that the continued functioning of the modified object code is in no case prevented or interfered with solely because modification has been made.

If you convey an object code work under this section in, or with, or specifically for use in, a User Product, and the conveying occurs as part of a transaction in which the right of possession and use of the User Product is transferred to the recipient in perpetuity or for a fixed term (regardless of how the transaction is characterized), the Corresponding Source conveyed under this section must be accompanied by the Installation Information. But this requirement does not apply if neither you nor any third party retains the ability to install modified object code on the User Product (for example, the work has been installed in ROM).

The requirement to provide Installation Information does not include a requirement to continue to provide support service, warranty, or updates for a work that has been modified or installed by the recipient, or for the User Product in which it has been modified or installed. Access to a network may be denied when the modification itself materially and adversely affects the operation of the network or violates the rules and protocols for communication across the network.

Corresponding Source conveyed, and Installation Information provided, in accord with this section must be in a format that is publicly documented (and with an implementation available to the public in source code form), and must require no special password or key for unpacking, reading or copying.

7. Additional Terms.

"Additional permissions" are terms that supplement the terms of this License by making exceptions from one or more of its conditions. Additional permissions that are applicable to the entire Program shall be treated as though they were included in this License, to the extent that they are valid under applicable law. If additional permissions apply only to part of the Program, that part may be used separately under those permissions, but the entire Program remains governed by this License without regard to the additional permissions.

When you convey a copy of a covered work, you may at your option remove any additional permissions from that copy, or from any part of it. (Additional permissions may be written to require their own removal in certain cases when you modify the work.) You may place additional permissions on material, added by you to a covered work, for which you have or can give appropriate copyright permission.

Notwithstanding any other provision of this License, for material you add to a covered work, you may (if authorized by the copyright holders of that material) supplement the terms of this License with terms:

- a) Disclaiming warranty or limiting liability differently from the terms of sections 15 and 16 of this License; or
- b) Requiring preservation of specified reasonable legal notices or author attributions in that material or in the Appropriate Legal Notices displayed by works containing it; or
- c) Prohibiting misrepresentation of the origin of that material, or requiring that modified versions of such material be marked in reasonable ways as different from the original version; or
- d) Limiting the use for publicity purposes of names of licensors or authors of the material; or
- e) Declining to grant rights under trademark law for use of some trade names, trademarks, or service marks; or
- f) Requiring indemnification of licensors and authors of that material by anyone who conveys the material (or modified versions of it) with contractual assumptions of liability to the recipient, for any liability that these contractual assumptions directly impose on those licensors and authors.

All other non-permissive additional terms are considered "further restrictions" within the meaning of section 10. If the Program as you received it, or any part of it, contains a notice stating that it is governed by this License along with a term that is a further restriction, you may remove that term. If a license document contains a further restriction but permits relicensing or conveying under this License, you may add to a covered work material governed by the terms of that license document, provided that the further restriction does not survive such relicensing or conveying.

If you add terms to a covered work in accord with this section, you must place, in the relevant source files, a statement of the additional terms that apply to those files, or a notice indicating where to find the applicable terms.

Additional terms, permissive or non-permissive, may be stated in the form of a separately written license, or stated as exceptions; the above requirements apply either way.

8. Termination.

You may not propagate or modify a covered work except as expressly provided under this License. Any attempt otherwise to propagate or modify it is void, and will automatically terminate your rights under this License (including any patent licenses granted under the third paragraph of section 11).

However, if you cease all violation of this License, then your license from a particular copyright holder is reinstated (a) provisionally, unless and until the copyright holder explicitly and finally terminates your license, and (b) permanently, if the copyright holder fails to notify you of the violation by some reasonable means prior to 60 days after the cessation.

Moreover, your license from a particular copyright holder is reinstated permanently if the copyright holder notifies you of the violation by some reasonable means, this is the first time you have received notice of violation of this License (for any work) from that copyright holder, and you cure the violation prior to 30 days after your receipt of the notice.

Termination of your rights under this section does not terminate the licenses of parties who have received copies or rights from you under this License. If your rights have been terminated and not permanently reinstated, you do not qualify to receive new licenses for the same material under section 10.

9. Acceptance Not Required for Having Copies.

You are not required to accept this License in order to receive or run a copy of the Program. Ancillary propagation of a covered work occurring solely as a consequence of using peer-to-peer transmission to receive a copy likewise does not require acceptance. However, nothing other than this License grants you permission to propagate or modify any covered work. These actions infringe copyright if you do not accept this License. Therefore, by modifying or propagating a covered work, you indicate your acceptance of this License to do so.

10. Automatic Licensing of Downstream Recipients.

Each time you convey a covered work, the recipient automatically receives a license from the original licensors, to run, modify and propagate that work, subject to this License. You are not responsible for enforcing compliance by third parties with this License.

An "entity transaction" is a transaction transferring control of an organization, or substantially all assets of one, or subdividing an organization, or merging organizations. If propagation of a covered work results from an entity transaction, each party to that transaction who receives a copy of the work also receives whatever licenses to the work the party's predecessor in interest had or could give under the previous paragraph, plus a right to possession of the Corresponding Source of the work from the predecessor in interest, if the predecessor has it or can get it with reasonable efforts.

You may not impose any further restrictions on the exercise of the rights granted or affirmed under this License. For example, you may not impose a license fee, royalty, or other charge for exercise of rights granted under this License, and you may not initiate litigation (including a cross-claim or counterclaim in a lawsuit) alleging that any patent claim is infringed by making, using, selling, offering for sale, or importing the Program or any portion of it.

11. Patents.

A "contributor" is a copyright holder who authorizes use under this License of the Program or a work on which the Program is based. The work thus licensed is called the contributor's "contributor version".

A contributor's "essential patent claims" are all patent claims owned or controlled by the contributor, whether already acquired or hereafter acquired, that would be infringed by some manner, permitted by this License, of making, using, or selling its contributor version, but do not include claims that would be infringed only as a consequence of further modification of the contributor version. For purposes of this definition, "control" includes the right to grant patent sublicenses in a manner consistent with the requirements of this License.

Each contributor grants you a non-exclusive, worldwide, royalty-free patent license under the contributor's essential patent claims, to make, use, sell, offer for sale, import and otherwise run, modify and propagate the contents of its contributor version.

In the following three paragraphs, a "patent license" is any express agreement or commitment, however denominated, not to enforce a patent (such as an express permission to practice a patent or covenant not to sue for patent infringement). To "grant" such a patent license to a party means to make such an agreement or commitment not to enforce a patent against the party.

If you convey a covered work, knowingly relying on a patent license, and the Corresponding Source of the work is not available for anyone to copy, free of charge and under the terms of this License, through a publicly available network server or other readily accessible means, then you must either (1) cause the Corresponding Source to be so available, or (2) arrange to deprive yourself of the benefit of the patent license for this particular work, or (3) arrange, in a manner consistent with the requirements of this License, to extend the patent license to downstream recipients. "Knowingly relying" means you have actual knowledge that, but for the patent license, your conveying the covered work in a country, or your recipient's use of the covered work in a country, would infringe one or more identifiable patents in that country that you have reason to believe are valid.

If, pursuant to or in connection with a single transaction or arrangement, you convey, or propagate by procuring conveyance of, a covered work, and grant a patent license to some of the parties receiving the covered work authorizing them to use, propagate, modify or convey a specific copy of the covered work, then the patent license you grant is automatically extended to all recipients of the covered work and works based on it.

A patent license is "discriminatory" if it does not include within the scope of its coverage, prohibits the exercise of, or is conditioned on the non-exercise of one or more of the rights that are specifically granted under this License. You may not convey a covered work if you are a party to an arrangement with a third party that is in the business of distributing software, under which you make payment to the third party based on the extent of your activity of conveying the work, and under which the third party grants, to any of the parties who would receive the covered work from you, a discriminatory patent license (a) in connection with copies of the covered work conveyed by you (or copies made from those copies), or (b) primarily for and in connection with specific products or compilations that contain the covered work, unless you entered into that arrangement, or that patent license was granted, prior to 28 March 2007.

Nothing in this License shall be construed as excluding or limiting any implied license or other defenses to infringement that may otherwise be available to you under applicable patent law.

12. No Surrender of Others' Freedom.

If conditions are imposed on you (whether by court order, agreement or otherwise) that contradict the conditions of this License, they do not excuse you from the conditions of this License. If you cannot convey a covered work so as to satisfy simultaneously your obligations under this License and any other pertinent obligations, then as a consequence you may not convey it at all. For example, if you agree to terms that obligate you to collect a royalty for further conveying from those to whom you convey the Program, the only way you could satisfy both those terms and this License would be to refrain entirely from conveying the Program.

13. Use with the GNU Affero General Public License.

Notwithstanding any other provision of this License, you have permission to link or combine any covered work with a work licensed under version 3 of the GNU Affero General Public License into a single combined work, and to convey the resulting work. The terms of this License will continue to apply to the part which is the covered work, but the special requirements of the GNU Affero General Public License, section 13, concerning interaction through a network will apply to the combination as such.

14. Revised Versions of this License.

The Free Software Foundation may publish revised and/or new versions of the GNU General Public License from time to time. Such new versions will be similar in spirit to the present version, but may differ in detail to address new problems or concerns.

Each version is given a distinguishing version number. If the Program specifies that a certain numbered version of the GNU General Public License "or any later version" applies to it, you have the option of following the terms and conditions either of that numbered version or of any later version published by the Free Software Foundation. If the Program does not specify a version number of the GNU General Public License, you may choose any version ever published by the Free Software Foundation.

If the Program specifies that a proxy can decide which future versions of the GNU General Public License can be used, that proxy's public statement of acceptance of a version permanently authorizes you to choose that version for the Program.

Later license versions may give you additional or different permissions. However, no additional obligations are imposed on any author or copyright holder as a result of your choosing to follow a later version.

15. Disclaimer of Warranty.

THERE IS NO WARRANTY FOR THE PROGRAM, TO THE EXTENT PERMITTED BY APPLICABLE LAW. EXCEPT WHEN OTHERWISE STATED IN WRITING THE COPYRIGHT HOLDERS AND/OR OTHER PARTIES PROVIDE THE PROGRAM "AS IS" WITHOUT WARRANTY OF ANY KIND, EITHER EXPRESSED OR IMPLIED, INCLUDING, BUT NOT LIMITED TO, THE IMPLIED WARRANTIES OF MERCHANTABILITY AND FITNESS FOR A PARTICULAR PURPOSE. THE ENTIRE RISK AS TO THE QUALITY AND PERFORMANCE OF THE PROGRAM IS WITH YOU. SHOULD THE PROGRAM PROVE DEFECTIVE, YOU ASSUME THE COST OF ALL NECESSARY SERVICING, REPAIR OR CORRECTION.

16. Limitation of Liability.

IN NO EVENT UNLESS REQUIRED BY APPLICABLE LAW OR AGREED TO IN WRITING WILL ANY COPYRIGHT HOLDER, OR ANY OTHER PARTY WHO MODIFIES AND/OR CONVEYS THE PROGRAM AS PERMITTED ABOVE, BE LIABLE TO YOU FOR DAMAGES, INCLUDING ANY GENERAL, SPECIAL, INCIDENTAL OR CONSEQUENTIAL DAMAGES ARISING OUT OF THE USE OR INABILITY TO USE THE PROGRAM (INCLUDING BUT NOT LIMITED TO LOSS OF DATA OR DATA BEING RENDERED INACCURATE OR LOSSES SUSTAINED BY YOU OR THIRD PARTIES OR A FAILURE OF THE PROGRAM TO OPERATE WITH ANY OTHER PROGRAMS), EVEN IF SUCH HOLDER OR OTHER PARTY HAS BEEN ADVISED OF THE POSSIBILITY OF SUCH DAMAGES.

17. Interpretation of Sections 15 and 16.

If the disclaimer of warranty and limitation of liability provided above cannot be given local legal effect according to their terms, reviewing courts shall apply local law that most closely approximates an absolute waiver of all civil liability in connection with the Program, unless a warranty or assumption of liability accompanies a copy of the Program in return for a fee.

END OF TERMS AND CONDITIONS

GNU LESSER GENERAL PUBLIC LICENSE

Version 2.1, February 1999

Copyright (C) 1991, 1999 Free Software Foundation, Inc.

51 Franklin Street, Fifth Floor, Boston, MA 02110-1301 USA

Everyone is permitted to copy and distribute verbatim copies of this license document, but changing it is not allowed.

[This is the first released version of the Lesser GPL.

It also counts as the successor of the GNU Library Public License, version 2, hence the version number 2.1.]

Preamble

The licenses for most software are designed to take away your freedom to share and change it. By contrast, the GNU General Public Licenses are intended to guarantee your freedom to share and change free software to make sure the software is free for all its users.

This license, the Lesser General Public License, applies to some specially designated software packages--typically libraries--of the Free Software Foundation and other authors who decide to use it. You can use it too, but we suggest you first think carefully about whether this license or the ordinary General Public License is the better strategy to use in any particular case, based on the explanations below.

When we speak of free software, we are referring to freedom of use, not price. Our General Public Licenses are designed to make sure that you have the freedom to distribute copies of free software (and charge for this service if you wish); that you receive source code or can get it if you want it; that you can change the software and use pieces of it in new free

programs; and that you are informed that you can do these things.

To protect your rights, we need to make restrictions that forbid distributors to deny you these rights or to ask you to surrender these rights. These restrictions translate to certain responsibilities for you if you distribute copies of the library or if you modify it.

For example, if you distribute copies of the library, whether gratis or for a fee, you must give the recipients all the rights that we gave you. You must make sure that they, too, receive or can get the source code. If you link other code with the library, you must provide complete object files to the recipients, so that they can relink them with the library after making changes to the library and recompiling it. And you must show them these terms so they know their rights.

We protect your rights with a two-step method: (1) we copyright the library, and (2) we offer you this license, which gives you legal permission to copy, distribute and/or modify the library.

To protect each distributor, we want to make it very clear that there is no warranty for the free library. Also, if the library is modified by someone else and passed on, the recipients should know that what they have is not the original version, so that the original author's reputation will not be affected by problems that might be introduced by others.

Finally, software patents pose a constant threat to the existence of any free program. We wish to make sure that a company cannot effectively restrict the users of a free program by obtaining a restrictive license from a patent holder. Therefore, we insist that any patent license obtained for a version of the library must be consistent with the full freedom of use specified in this license.

Most GNU software, including some libraries, is covered by the ordinary GNU General Public License. This license, the GNU Lesser General Public License, applies to certain designated libraries, and is quite different from the ordinary General Public License. We use this license for certain libraries in order to permit linking those libraries into non-free programs.

When a program is linked with a library, whether statically or using a shared library, the combination of the two is legally speaking a combined work, a derivative of the original library. The ordinary General Public License therefore permits such linking only if the entire combination fits its criteria of freedom. The Lesser General Public License permits more lax criteria for linking other code with the library.

We call this license the "Lesser" General Public License because it does Less to protect the user's freedom than the ordinary General Public License. It also provides other free software developers Less of an advantage over competing non-free programs. These disadvantages are the reason we use the ordinary General Public License for many libraries. However, the Lesser license provides advantages in certain special circumstances.

For example, on rare occasions, there may be a special need to encourage the widest possible use of a certain library, so that it becomes a de-facto standard. To achieve this, non-free programs must be allowed to use the library. A more frequent case is that a free library does the same job as widely used non-free libraries. In this case, there is little to gain by limiting the free library to free software only, so we use the Lesser General Public License.

In other cases, permission to use a particular library in non-free programs enables a greater number of people to use a large body of free software. For example, permission to use the GNU C Library in non-free programs enables many more people to use the whole GNU operating system, as well as its variant, the GNU/Linux operating system.

Although the Lesser General Public License is Less protective of the users' freedom, it does ensure that the user of a program that is linked with the Library has the freedom and the wherewithal to run that program using a modified version of the Library.

The precise terms and conditions for copying, distribution and modification follow. Pay close attention to the difference between a "work based on the library" and a "work that uses the library". The former contains code derived from the library, whereas the latter must be combined with the library in order to run.

TERMS AND CONDITIONS FOR COPYING, DISTRIBUTION AND MODIFICATION

0. This License Agreement applies to any software library or other program which contains a notice placed by the copyright holder or other authorized party saying it may be distributed under the terms of this Lesser General Public License (also called "this License"). Each licensee is addressed as "you".

A "library" means a collection of software functions and/or data prepared so as to be conveniently linked with application programs (which use some of those functions and data) to form executables.

The "Library", below, refers to any such software library or work which has been distributed under these terms. A "work based on the Library" means either the Library or any derivative work under copyright law: that is to say, a work containing the Library or a portion of it, either verbatim or with modifications and/or translated straightforwardly into another language. (Hereinafter, translation is included without limitation in the term "modification".)

"Source code" for a work means the preferred form of the work for making modifications to it. For a library, complete source code means all the source code for all modules it contains, plus any associated interface definition files, plus the scripts used to control compilation and installation of the library.

Activities other than copying, distribution and modification are not covered by this License; they are outside its scope. The act of running a program using the Library is not restricted, and output from such a program is covered only if its contents constitute a work based on the Library (independent of the use of the Library in a tool for writing it). Whether that is true depends on what the Library does and what the program that uses the Library does.

1. You may copy and distribute verbatim copies of the Library's complete source code as you receive it, in any medium, provided that you conspicuously and appropriately publish on each copy an appropriate copyright notice and disclaimer of warranty; keep intact all the notices that refer to this License and to the absence of any warranty; and distribute a copy of this License along with the Library.

You may charge a fee for the physical act of transferring a copy, and you may at your option offer warranty protection in exchange for a fee.

2. You may modify your copy or copies of the Library or any portion of it, thus forming a work based on the Library, and copy and distribute such modifications or work under the terms of Section 1 above, provided that you also meet all of these conditions:

- a) The modified work must itself be a software library.
- b) You must cause the files modified to carry prominent notices stating that you changed the files and the date of any change.
- c) You must cause the whole of the work to be licensed at no charge to all third parties under the terms of this License.
- d) If a facility in the modified Library refers to a function or a table of data to be supplied by an application program that uses the facility, other than as an argument passed when the facility is invoked, then you must make a good faith effort to ensure that, in the event an application does not supply such function or table, the facility still operates, and performs whatever part of its purpose remains meaningful.

(For example, a function in a library to compute square roots has a purpose that is entirely well-defined independent of the application. Therefore, Subsection 2d requires that any application-supplied function or table used by this function must be optional: if the application does not supply it, the square root function must still compute square roots.)

These requirements apply to the modified work as a whole. If identifiable sections of that work are not derived from the Library, and can be reasonably considered independent and separate works in themselves, then this License, and its terms, do not apply to those sections when you distribute them as separate works. But when you distribute the same sections as part of a whole which is a work based on the Library, the distribution of the whole must be on the terms of this License, whose permissions for other licensees extend to the entire whole, and thus to each and every part regardless of who wrote it.

Thus, it is not the intent of this section to claim rights or contest your rights to work written entirely by you; rather, the intent is to exercise the right to control the distribution of derivative or collective works based on the Library.

In addition, mere aggregation of another work not based on the Library with the Library (or with a work based on the Library) on a volume of a storage or distribution medium does not bring the other work under the scope of this License.

3. You may opt to apply the terms of the ordinary GNU General Public License instead of this License to a given copy of the Library. To do this, you must alter all the notices that refer to this License, so that they refer to

the ordinary GNU General Public License, version 2, instead of to this License. (If a newer version than version 2 of the ordinary GNU General Public License has appeared, then you can specify that version instead if you wish.) Do not make any other change in these notices.

Once this change is made in a given copy, it is irreversible for that copy, so the ordinary GNU General Public License applies to all subsequent copies and derivative works made from that copy.

This option is useful when you wish to copy part of the code of the Library into a program that is not a library.

4. You may copy and distribute the Library (or a portion or derivative of it, under Section 2) in object code or executable form under the terms of Sections 1 and 2 above provided that you accompany it with the complete corresponding machine-readable source code, which must be distributed under the terms of Sections 1 and 2 above on a medium customarily used for software interchange.

If distribution of object code is made by offering access to copy from a designated place, then offering equivalent access to copy the source code from the same place satisfies the requirement to distribute the source code, even though third parties are not compelled to copy the source along with the object code.

5. A program that contains no derivative of any portion of the Library, but is designed to work with the Library by being compiled or linked with it, is called a "work that uses the Library". Such a work, in isolation, is not a derivative work of the Library, and therefore falls outside the scope of this License.

However, linking a "work that uses the Library" with the Library creates an executable that is a derivative of the Library (because it contains portions of the Library), rather than a "work that uses the library". The executable is therefore covered by this License. Section 6 states terms for distribution of such executables.

When a "work that uses the Library" uses material from a header file that is part of the Library, the object code for the work may be a derivative work of the Library even though the source code is not. Whether this is true is especially significant if the work can be linked without the Library, or if the work is itself a library. The threshold for this to be true is not precisely defined by law.

If such an object file uses only numerical parameters, data structure layouts and accessors, and small macros and small inline functions (ten lines or less in length), then the use of the object file is unrestricted, regardless of whether it is legally a derivative work. (Executables containing this object code plus portions of the Library will still fall under Section 6.)

Otherwise, if the work is a derivative of the Library, you may distribute the object code for the work under the terms of Section 6. Any executables containing that work also fall under Section 6, whether or not they are linked directly with the Library itself.

6. As an exception to the Sections above, you may also combine or link a "work that uses the Library" with the Library to produce a work containing portions of the Library, and distribute that work under terms of your choice, provided that the terms permit modification of the work for the customer's own use and reverse engineering for debugging such modifications.

You must give prominent notice with each copy of the work that the Library is used in it and that the Library and its use are covered by this License. You must supply a copy of this License. If the work during execution displays copyright notices, you must include the copyright notice for the Library among them, as well as a reference directing the user to the copy of this License. Also, you must do one of these things:

- a) Accompany the work with the complete corresponding machine-readable source code for the Library including whatever changes were used in the work (which must be distributed under Sections 1 and 2 above); and, if the work is an executable linked with the Library, with the complete machine readable "work that uses the Library", as object code and/or source code, so that the user can modify the Library and then relink to produce a modified executable containing the modified Library. (It is understood that the user who changes the contents of definitions files in the Library will not necessarily be able to recompile the application to use the modified definitions.)

- b) Use a suitable shared library mechanism for linking with the Library. A suitable mechanism is one that (1) uses at run time a copy of the library already present on the user's computer system, rather than copying library functions into the executable, and (2) will operate properly with a modified version of the library, if the user installs one, as long as the modified version is interface-compatible with the version that the work was made with.
- c) Accompany the work with a written offer, valid for at least three years, to give the same user the materials specified in Subsection 6a, above, for a charge no more than the cost of performing this distribution.
- d) If distribution of the work is made by offering access to copy from a designated place, offer equivalent access to copy the above specified materials from the same place.
- e) Verify that the user has already received a copy of these materials or that you have already sent this user a copy.

For an executable, the required form of the "work that uses the Library" must include any data and utility programs needed for reproducing the executable from it. However, as a special exception, the materials to be distributed need not include anything that is normally distributed (in either source or binary form) with the major components (compiler, kernel, and so on) of the operating system on which the executable runs, unless that component itself accompanies the executable.

It may happen that this requirement contradicts the license restrictions of other proprietary libraries that do not normally accompany the operating system. Such a contradiction means you cannot use both them and the Library together in an executable that you distribute.

7. You may place library facilities that are a work based on the Library side-by-side in a single library together with other library facilities not covered by this License, and distribute such a combined library, provided that the separate distribution of the work based on the Library and of the other library facilities is otherwise permitted, and provided that you do these two things:

- a) Accompany the combined library with a copy of the same work based on the Library, uncombined with any other library facilities. This must be distributed under the terms of the Sections above.
- b) Give prominent notice with the combined library of the fact that part of it is a work based on the Library, and explaining where to find the accompanying uncombined form of the same work.

8. You may not copy, modify, sublicense, link with, or distribute the Library except as expressly provided under this License. Any attempt otherwise to copy, modify, sublicense, link with, or distribute the Library is void, and will automatically terminate your rights under this License. However, parties who have received copies, or rights, from you under this License will not have their licenses terminated so long as such parties remain in full compliance.

9. You are not required to accept this License, since you have not signed it. However, nothing else grants you permission to modify or distribute the Library or its derivative works. These actions are prohibited by law if you do not accept this License. Therefore, by modifying or distributing the Library (or any work based on the Library), you indicate your acceptance of this License to do so, and all its terms and conditions for copying, distributing or modifying the Library or works based on it.

10. Each time you redistribute the Library (or any work based on the Library), the recipient automatically receives a license from the original licensor to copy, distribute, link with or modify the Library subject to these terms and conditions. You may not impose any further restrictions on the recipients' exercise of the rights granted herein. You are not responsible for enforcing compliance by third parties with this License.

11. If, as a consequence of a court judgment or allegation of patent infringement or for any other reason (not limited to patent issues), conditions are imposed on you (whether by court order, agreement or otherwise) that contradict the conditions of this License, they do not excuse you from the conditions of this License. If you cannot distribute so as to satisfy simultaneously your obligations under this License and any other pertinent obligations, then as a consequence you may not distribute

the Library at all. For example, if a patent license would not permit royalty free redistribution of the Library by all those who receive copies directly or indirectly through you, then the only way you could satisfy both it and this License would be to refrain entirely from distribution of the Library.

If any portion of this section is held invalid or unenforceable under any particular circumstance, the balance of the section is intended to apply, and the section as a whole is intended to apply in other circumstances.

It is not the purpose of this section to induce you to infringe any patents or other property right claims or to contest validity of any such claims; this section has the sole purpose of protecting the integrity of the free software distribution system which is implemented by public license practices. Many people have made generous contributions to the wide range of software distributed through that system in reliance on consistent application of that system; it is up to the author/donor to decide if he or she is willing to distribute software through any other system and a licensee cannot impose that choice.

This section is intended to make thoroughly clear what is believed to be a consequence of the rest of this License.

12. If the distribution and/or use of the Library is restricted in certain countries either by patents or by copyrighted interfaces, the original copyright holder who places the Library under this License may add an explicit geographical distribution limitation excluding those countries, so that distribution is permitted only in or among countries not thus excluded. In such case, this License incorporates the limitation as if written in the body of this License.

13. The Free Software Foundation may publish revised and/or new versions of the Lesser General Public License from time to time. Such new versions will be similar in spirit to the present version, but may differ in detail to address new problems or concerns.

Each version is given a distinguishing version number. If the Library specifies a version number of this License which applies to it and "any later version", you have the option of following the terms and conditions either of that version or of any later version published by the Free Software Foundation. If the Library does not specify a license version number, you may choose any version ever published by the Free Software Foundation.

14. If you wish to incorporate parts of the Library into other free programs whose distribution conditions are incompatible with these, write to the author to ask for permission. For software which is copyrighted by the Free Software Foundation, write to the Free Software Foundation; we sometimes make exceptions for this. Our decision will be guided by the two goals of preserving the free status of all derivatives of our free software and of promoting the sharing and reuse of software generally.

NO WARRANTY

15. BECAUSE THE LIBRARY IS LICENSED FREE OF CHARGE, THERE IS NO WARRANTY FOR THE LIBRARY, TO THE EXTENT PERMITTED BY APPLICABLE LAW. EXCEPT WHEN OTHERWISE STATED IN WRITING THE COPYRIGHT HOLDERS AND/OR OTHER PARTIES PROVIDE THE LIBRARY "AS IS" WITHOUT WARRANTY OF ANY KIND, EITHER EXPRESSED OR IMPLIED, INCLUDING, BUT NOT LIMITED TO, THE IMPLIED WARRANTIES OF MERCHANTABILITY AND FITNESS FOR A PARTICULAR PURPOSE. THE ENTIRE RISK AS TO THE QUALITY AND PERFORMANCE OF THE LIBRARY IS WITH YOU. SHOULD THE LIBRARY PROVE DEFECTIVE, YOU ASSUME THE COST OF ALL NECESSARY SERVICING, REPAIR OR CORRECTION.

16. IN NO EVENT UNLESS REQUIRED BY APPLICABLE LAW OR AGREED TO IN WRITING WILL ANY COPYRIGHT HOLDER, OR ANY OTHER PARTY WHO MAY MODIFY AND/OR REDISTRIBUTE THE LIBRARY AS PERMITTED ABOVE, BE LIABLE TO YOU FOR DAMAGES, INCLUDING ANY GENERAL, SPECIAL, INCIDENTAL OR CONSEQUENTIAL DAMAGES ARISING OUT OF THE USE OR INABILITY TO USE THE LIBRARY (INCLUDING BUT NOT LIMITED TO LOSS OF DATA OR DATA BEING RENDERED INACCURATE OR LOSSES SUSTAINED BY YOU OR THIRD PARTIES OR A FAILURE OF THE LIBRARY TO OPERATE WITH ANY OTHER SOFTWARE), EVEN IF SUCH HOLDER OR OTHER PARTY HAS BEEN ADVISED OF THE POSSIBILITY OF SUCH DAMAGES.

END OF TERMS AND CONDITIONS

How to Apply These Terms to Your New Libraries

If you develop a new library, and you want it to be of the greatest possible use to the public, we recommend making it free software that everyone can redistribute and change. You can do so by permitting redistribution under these terms (or, alternatively, under the terms of the ordinary General Public License).

To apply these terms, attach the following notices to the library. It is safest to attach them to the start of each source file to most effectively convey the exclusion of warranty; and each file should have at least the "copyright" line and a pointer to where the full notice is found. one line to give the library's name and an idea of what it does.

Copyright (C) year name of author

This library is free software; you can redistribute it and/or modify it under the terms of the GNU Lesser General Public License as published by the Free Software Foundation; either version 2.1 of the License, or (at your option) any later version.

This library is distributed in the hope that it will be useful, but WITHOUT ANY WARRANTY; without even the implied warranty of MERCHANTABILITY or FITNESS FOR A PARTICULAR PURPOSE. See the GNU Lesser General Public License for more details.

You should have received a copy of the GNU Lesser General Public License along with this library; if not, write to the Free Software Foundation, Inc., 51 Franklin Street, Fifth Floor, Boston, MA 02110-1301 USA Also add information on how to contact you by electronic and paper mail.

You should also get your employer (if you work as a programmer) or your school, if any, to sign a "copyright disclaimer" for the library, if necessary. Here is a sample; alter the names:

Yoyodyne, Inc., hereby disclaims all copyright interest in the library 'Frob' (a library for tweaking knobs) written by James Random Hacker.

signature of Ty Coon, 1 April 1990 Ty Coon, President of Vice.

OpenSSL LICENSE

Copyright (c) 1998-2006 The OpenSSL Project. All rights reserved. Redistribution and use in source and binary forms, with or without modification, are permitted provided that the following conditions are met:

1. Redistributions of source code must retain the above copyright notice, this list of conditions and the following disclaimer.
2. Redistributions in binary form must reproduce the above copyright notice, this list of conditions and the following disclaimer in the documentation and/or other materials provided with the distribution.
3. All advertising materials mentioning features or use of this software must display the following acknowledgment: "This product includes software developed by the OpenSSL Project for use in the OpenSSL Toolkit. (<http://www.openssl.org/>)"
4. The names "OpenSSL Toolkit" and "OpenSSL Project" must not be used to endorse or promote products derived from this software without prior written permission. For written permission, please contact openssl-core@openssl.org.
5. Products derived from this software may not be called "OpenSSL." nor may "OpenSSL." appear in their names without prior written permission of the OpenSSL Project.
6. Redistributions of any form whatsoever must retain the following acknowledgment: "This product includes software developed by the OpenSSL Project for use in the OpenSSL Toolkit (<http://www.openssl.org/>)"

THIS SOFTWARE IS PROVIDED BY THE OpenSSL PROJECT "AS IS" AND ANY EXPRESSED OR IMPLIED WARRANTIES, INCLUDING, BUT NOT LIMITED TO, THE IMPLIED WARRANTIES OF MERCHANTABILITY AND FITNESS FOR A PARTICULAR PURPOSE ARE DISCLAIMED. IN NO EVENT SHALL THE OpenSSL PROJECT OR ITS CONTRIBUTORS BE LIABLE FOR ANY DIRECT, INDIRECT, INCIDENTAL, SPECIAL, EXEMPLARY, OR CONSEQUENTIAL DAMAGES (INCLUDING, BUT NOT LIMITED TO, PROCUREMENT OF SUBSTITUTE GOODS OR SERVICES; LOSS OF USE, DATA, OR PROFITS; OR BUSINESS INTERRUPTION) HOWEVER CAUSED AND ON ANY THEORY OF LIABILITY, WHETHER IN CONTRACT, STRICT LIABILITY, OR TORT (INCLUDING NEGLIGENCE OR OTHERWISE) ARISING IN ANY WAY OUT OF THE USE OF THIS SOFTWARE, EVEN IF ADVISED OF THE POSSIBILITY OF SUCH DAMAGE. This product includes cryptographic software written by Eric Young (ey@cryptsoft.com). This product includes software written by Tim Hudson (tjh@cryptsoft.com).

Original SSLeay License

Copyright (C) 1995-1998 Eric Young (ey@cryptsoft.com) All rights reserved. This package is an SSL implementation written by Eric Young (ey@cryptsoft.com). The implementation was written so as to conform with Netscapes SSL. This library is free for commercial and non-commercial use as long as the following conditions are adhered to. The following conditions apply to all code found in this distribution, be it the RC4, RSA, lhash, DES, etc., code; not just the SSL code. The SSL documentation included with this distribution is covered by the same copyright terms except that the holder is Tim Hudson (tjh@cryptsoft.com).

Copyright remains Eric Young's, and as such any Copyright notices in the code are not to be removed.

If this package is used in a product, Eric Young should be given attribution as the author of the parts of the library used. This can be in the form of a textual message at program startup or in documentation (online or textual) provided with the package. Redistribution and use in source and binary forms, with or without modification, are permitted provided that the following conditions are met:

1. Redistributions of source code must retain the copyright notice, this list of conditions and the following disclaimer.
2. Redistributions in binary form must reproduce the above copyright notice, this list of conditions and the following disclaimer in the documentation and/or other materials provided with the distribution.
3. All advertising materials mentioning features or use of this software must display the following acknowledgement: "This product includes cryptographic software written by Eric Young (ey@cryptsoft.com)" The word 'cryptographic' can be left out if the routines from the library being used are not cryptographic related :-).
4. If you include any Windows specific code (or a derivative thereof) from the apps directory (application code) you must include an acknowledgement: "This product includes software written by Tim Hudson (tjh@cryptsoft.com)"

THIS SOFTWARE IS PROVIDED BY ERIC YOUNG "AS IS" AND ANY EXPRESS OR IMPLIED WARRANTIES, INCLUDING, BUT NOT LIMITED TO, THE IMPLIED WARRANTIES OF MERCHANTABILITY AND FITNESS FOR A PARTICULAR PURPOSE ARE DISCLAIMED. IN NO EVENT SHALL THE AUTHOR OR CONTRIBUTORS BE LIABLE FOR ANY DIRECT, INDIRECT, INCIDENTAL, SPECIAL, EXEMPLARY, OR CONSEQUENTIAL DAMAGES (INCLUDING, BUT NOT LIMITED TO, PROCUREMENT OF SUBSTITUTE GOODS OR SERVICES; LOSS OF USE, DATA, OR PROFITS; OR BUSINESS INTERRUPTION) HOWEVER CAUSED AND ON ANY THEORY OF LIABILITY, WHETHER IN CONTRACT, STRICT LIABILITY, OR TORT (INCLUDING NEGLIGENCE OR OTHERWISE) ARISING IN ANY WAY OUT OF THE USE OF THIS SOFTWARE, EVEN IF ADVISED OF THE POSSIBILITY OF SUCH DAMAGE. The licence and distribution terms for any publically available version or derivative of this code cannot be changed. i.e. this code cannot simply be copied and put under another distribution licence [including the GNU Public Licence.

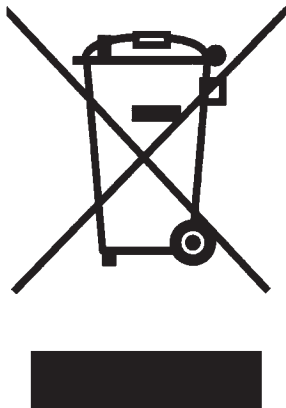

English

Disposal of your old appliance

1. When this crossed-out wheeled bin symbol is attached to a product it means the product is covered by the European Directive 2002/96/EC.
2. All electrical and electronic products should be disposed of separately from the municipal waste stream via designated collection facilities appointed by the government or the local authorities.
3. The correct disposal of your old appliance will help prevent potential negative consequences for the environment and human health.
4. For more detailed information about disposal of your old appliance, please contact your city office, waste disposal service or the shop where you purchased the product.

Français/French

Élimination de votre ancien appareil

1. Ce symbole, représentant une poubelle sur roulettes barrée d'une croix, signifie que le produit est couvert par la directive européenne 2002/96/EC.
2. Tous les produits électriques et électroniques doivent être éliminés séparément de la chaîne de collecte municipale des ordures, par l'intermédiaire des installations de collecte prescrites et désignées par le gouvernement ou les autorités locales.
3. Une élimination conforme aux instructions aidera à réduire les conséquences négatives et risques éventuels pour l'environnement et la santé humaine.
4. Pour plus d'informations concernant l'élimination de votre ancien appareil, veuillez contacter votre mairie, le service des ordures ménagères ou encore le magasin où vous avez acheté ce produit.

Deutsch/German

Entsorgung von Altgeräten

1. Wenn dieses Symbol eines durchgestrichenen Abfalleimers auf einem Produkt angebracht ist, unterliegt dieses Produkt der europäischen Richtlinie 2002/96/EC.
2. Alle Elektro- und Elektronik-Altgeräte müssen getrennt vom Hausmüll über die dafür staatlich vorgesehenen Stellen entsorgt werden.
3. Mit der ordnungsgemäßen Entsorgung des alten Geräts vermeiden Sie Umweltschäden und eine Gefährdung der persönlichen Gesundheit.
4. Weitere Informationen zur Entsorgung des alten Geräts erhalten Sie bei der Stadtverwaltung, beim Entsorgungsamt oder in dem Geschäft, wo Sie das Produkt erworben haben.

Italiano/Italian

RAEE: SMALTIMENTO DELLE VOSTRE VECCHIE APPARECCHIATURE

1. Quando il simbolo del "Cassonetto Barrato" è apposto su un prodotto, significa che lo stesso può ricadere nei termini previsti dalla Direttiva Europea nr. 2002/96/EC in funzione dell'attuazione definita dalla Legislazione dei singoli stati membri dell'Unione Europea.
2. Tutti i prodotti elettrici ed elettronici dovrebbero essere smaltiti separatamente dai rifiuti municipali, tramite appositi contenitori, approvati dall'Amministrazione Comunale o dalle Autorità Locali.
3. Il corretto smaltimento delle vostre vecchie apparecchiature, contribuirà a prevenire possibili conseguenze di impatto negativo sull'ambiente e per la salute dell'uomo.
4. Per maggiori informazioni circa lo smaltimento delle vostre vecchie apparecchiature, siete pregati di contattare l'ufficio municipale della vostra città, il servizio di smaltimento rifiuti o il punto vendita nel quale avete acquistato il prodotto.

Polski/Polish

Utylizacja starych urządzeń

1. Kiedy do produktu dołączony jest niniejszy przekreślony symbol kołowego pojemnika na śmieci, oznacza to, że produkt jest objęty europejską dyrektywą 2002/96/EC.
2. Wszystkie elektryczne i elektroniczne produkty powinny być utylizowane niezależnie od odpadów miejskich, z wykorzystaniem przeznaczonych do tego miejsc składowania wskazanych przez rząd lub miejscowe władze.
3. Właściwy sposób utylizacji starego urządzenia pomoże zapobiec potencjalnie negatywnemu wpływowi na zdrowie i środowisko.
4. Aby uzyskać więcej informacji o sposobach utylizacji starych urządzeń, należy skontaktować się z władzami lokalnymi, przedsiębiorstwem zajmującym się utylizacją odpadów lub sklepem, w którym produkt został kupiony.

Português/Portuguese

Eliminação do seu antigo aparelho

1. Quando este símbolo de latão cruzado estiver afixado a um produto, significa que o produto é abrangido pela Directiva Europeia 2002/96/EC.
2. Todos os produtos eléctricos e electrónicos devem ser eliminados separadamente da coleta de lixo municipal através de pontos de recolha designados, facilitados pelo governo ou autoridades locais.
3. A eliminação correcta do seu aparelho antigo ajuda a evitar potenciais consequências negativas para o ambiente e para a saúde humana.
4. Para obter informações mais detalhadas acerca da eliminação do seu aparelho antigo, contacte as autoridades locais, um serviço de eliminação de resíduos ou a loja onde comprou o produto.

Español/Spanish

Cómo deshacerse de aparatos eléctricos y electrónicos viejos

1. Si en un producto aparece el símbolo de un contenedor de basura tachado, significa que éste se acoge a la Directiva 2002/96/EC.
2. Todos los aparatos eléctricos o electrónicos se deben desechar de forma distinta del servicio municipal de recogida de basura, a través de puntos de recogida designados por el gobierno o las autoridades locales.
3. La correcta recogida y tratamiento de los dispositivos inservibles contribuye a evitar riesgos potenciales para el medio ambiente y la salud pública.
4. Para obtener más información sobre cómo deshacerse de sus aparatos eléctricos y electrónicos viejos, póngase en contacto con su ayuntamiento, el servicio de recogida de basuras o el establecimiento donde adquirió el producto.

America

CBC AMERICAS Corp. National HQ

2000 Regency Parkway, Suite 600,
Cary, NC 27518, U.S.A.

<http://www.computarganz.com/>

CBC AMERICAS Corp. Los Angeles Division

21241 South Western Avenue, Suite #160
Torrance, CA 90501, U.S.A.

<http://www.computarganz.com/>

CBC AMERICAS Corp. Mexico Branch Office

Galileo NO.20-101, Col. Polanco,
Miguel Hidalgo, 11500, MEXICO

<http://www.computarganz.com/>

Europe

CBC EUROPE GmbH Düsseldorf

Hansaallee 191,
D-40549 Düsseldorf, GERMANY

<http://www.cbc-europe.com/>

CBC EUROPE GmbH UK Branch London

Unit 9, Garrick Road Industrial Estate,
Irving Way, London NW9 6AQ, U.K.

<http://www.cbceurope.com/>

CBC EUROPE S.r.l. Milan

Via E. Majorana, 2
20834-Nova, Milanese (MB), ITALY

<http://www.cbceurope.it/cctv>

CBC(POLAND) Sp. z o.o. Warszawa

ul. Anny German 15,
01-794, Warszawa, POLAND

<http://www.cbcpoland.pl/>

CBC Co., Ltd. MOSCOW REP Office Moscow

Office 503B, Entrance #3, (Building 1)
World Trade Center, 12, Krasnopresnenskaya nab,
Moscow, 123610, RUSSIA

<http://www.cbc.ru/>

Asia

CBC. S Pte Ltd. Singapore

15 Jalan Kilang Barat, No.04-03
Frontech Centre, SINGAPORE 159357

<http://www.cbcsingapore.com/>

CBC (THAILAND) Co., Ltd. Bangkok

23rd Floor, ITF Tower 2, 140/53-55,
Silom Road, Suriyawongse,
Bangkok, Bangkok, 10500, THAILAND

<http://www.cbcthailand.com/>

CBC CORPORATION (INDIA) Pvt. Ltd. Mumbai

2nd Floor, B Wing, Marwah Centre,
Krishanlal Marwah Marg,
Andheri East, Mumbai 400 072, INDIA

PT. CBC PRIMA Jakarta

MidPlaza II Building 12th Floor,
Jl. Jend. Sudirman Kav.10-11,
Jakarta Pusat, 10220 Republic of INDONESIA

T-CBC (TAIWAN) Co., Ltd. Taiwan

Room D, 10th Floor, No.365 Fushing N. Rd.,
Taipei, 10579, Taiwan, R.O.C

<http://www.t-cbc.com.tw/>

China

CBC (BEIJING) Trading Co., Ltd. Beijing

Room B905-A, Tian Yuan Gang Center,
No.C2 Dong San Huan Bei-Lu,
Chaoyang District, Beijing CHINA 100027

<http://www.cbc-china.cn/>

CBC (SHANGHAI) Trading Co., Ltd. Shanghai

Room 1801, GIFC, No.1438 Hongqiao Road,
Changning District, Shanghai, CHINA 200336

<http://www.cbc-china.cn/>

CBC (GUANGZHOU) Trading Co., Ltd. Guangzhou

Room 1207, Citic Plaza, No.233 Tian He
North Road, Guangzhou City,
Guangdong Province, CHINA 510613

<http://www.cbc-china.cn/>

CBC (HONG KONG) Co., Ltd. Hong Kong

Unit 901, 9/F., Tower 5,
China Hong Kong City, 33 Canton Road,
Tsim Sha Tsui, Kowloon, Hong Kong, CHINA

<http://www.cbc-china.cn/>



CBC Co., Ltd. Head Office, Tokyo

Image & Information Technology Division
2-15-13, Tsukishima, Chuo-ku,
Tokyo 104-0052, JAPAN

<http://www.cbc.co.jp/en/index.html>

<http://www.ganz-global.com/>