Quick Installation Guide

Thank you for purchasing our NVR!

This operating manual is designed to be a reference tool for the installation and operation of your system.

Disclaimer: we reserve the right without notice to change, add, modify or remove any information and materials on this manual in any manner and at any time. All materials accurately go through carefully checking, but we shall not be responsible to bear the consequence if any errors.

CAUTION

- When you receive the NVR from the shipping agency, please check whether there is any visible damage to the NVR appearance.
- Open the box to check the accessories. Please check the items in accordance with the item list in the manual.
- Remove the protective film of the NVR
- The sticker on the bottom case is very important for our sales service, please keep it in a good situation, do not tear up or discard. It is needed to provide the product series number when you call for after sales service.

ITEMS LIST

Power Cable.....	1PCS
Remote Controller.....	1PCS
Mouse.....	1PCS
CD.....	1PCS
Operating Instruction.....	1PCS
Standoff.....	4PCS
8 Pin Green Screw Terminal.....	4PCS
Black Screw.....	10PCS
Screw for HDD.....	32PCS

HARDWARE ENVIRONMENT

Power: DC 12V power input

Cables: Cat 5 network cable, DC power cable

Temperature: 0°C~55°C, too heat or freeze will cause the malfunction of NVR, strictly prohibit to install the NVR above the heat source

Humidity: 10%~90%, keep the NVR away from rain or wet place, installation must stay away from water source

Ventilation: install the NVR in an airy place, keep away from dust

Installation: horizon installation or cabinet installation, protective casing needed when outdoor installation

1. CONTENTS

Part 1.....	Quick Installation Guide
Part 2.....	IE Operation
Part 3.....	CMS Operation
Part 4.....	IP Address and Ports Mapping Instruction
Part 5.....	DynDns Operation
Part 6.....	iPhone, iPad and Mobile Monitor Operation

2. FEATURES

- 25FPS (PAL) / 30FPS (NTSC) each channel recording
- H.264 dual-stream video compression
- Support 255 Channels CMS free
- Support 2.0 USB memory (USB flash Disk, USB HDD, USB CD/DVD Burner. etc)
- Easy backup method: network download to remote client
- Support 10M/100M Network Interface
- Web setting, playback and review, NVR status check and video storage.
- Fast and convenient shortcut operation: copy & paste for the same settings
- User Friendly GUI, front panel, remote control and mouse
- Support free DDNS server: Admin Vision Free DDNS
- Networking method: TCP, UTP, RTP, Multicast, DHCP, ADSL (PPPoE), DDNS, LAN, WEB, etc.
- Support 4 HDD X 3TB
- Support main mobile remote monitoring (Windows Mobile / Symbian / iPhone / iPad/ Android/BlackBerry, ect)
- Support VGA output
- Support monitor and 1TV output

3. TECHNICAL SPECIFICATIONS

Video Parameter	
Video Compression	H.264
Video Format	NTSC/PAL
Bit Rate Type	VBR/CBR
Video Output (BNC)	2CH
HDMI	Support
Frame Rate(FPS)	PAL 25, NTSC 30
Audio Parameter	
Audio Compression	G711a
Audio Output (RCA)	1CH
Interface	
USB (2.0)	2
Network	10M/100M
RS-485	Support

Panel Key	Support
IR Remote	Support
HDD Port	4HDD x 3TB
HDD Interface	SATA
Operation	
CMS	Support
IE Browser	Support
Mobile Monitor	Support
Function	
Backup	USB、HDD、Network
Event Log	Support
Search Mode	By Time/By Event Type
DDNS	Support
Network Service	PPPoE/NTP/DDNS/FTP
WIFI	Support
Other	
Alarm Input	16CH
Alarm Output	4CH
NVR Mode	16*1080P/16*720P/24*D1
Operating System	Linux
GUI	Support
Mobile Software	Iphone, Ipad, Windows mobile, Android, Symbian, Blackberry, etc.
Multi-Language	Support
Power Consumption(W)	≤8 (Without HDD)
Working Temperature	0 - 55℃
Size(mm)	L440 x W360 x H60
Weight(kg)	≤5.0 (Without HDD)







4. STRUCTURES OF NVR

4.1 Front Panel Instruction



4.2 Rear Panel Instruction



S/N	Key name	sign	Function
1	DC 12V	DC12V	For connecting the power cable
2	Audio Output	A-OUT	1CH RCA Audio Output
3	Video Output	VOUT-1, VOUT-2	2CH BNC Video Output
4	VGA		VGA output, such as monitor, LCD TV, projector
5	Net Interface		Net interface to connect to LAN or WAN
6	USB		Connect USB removable device, such as flash memory, mouse, USB removable disk and so on
7	H-DMI		For connecting HDMI cable
8	RS485 RS232		For connecting RS485/RS232 Device
9	Alarm		For connecting alarm device

4.3 Mouse

For right-hand mouse

The NVR could be operated by mouse, connect the USB mouse into the USB port in back panel.

Left click mouse	When you have selected one menu item, left click mouse to view menu content.
	Implement the control operation.
	Modify checkbox or motion detection status.
	Click combo box to pop up drop down list.
	In input box, you can select input methods. Left click the corresponding button on the panel you can input English character (small/capitalized), numeral, Chinese characters & special sign.
Double left click mouse	Implement special control operation such as double click one item in the file list to playback the video.
	In multiple-window mode, double left click one channel to view in full-window. Double left click current video again to go back to previous multiple-window mode.
Right click mouse	In real-time monitor mode, pops up shortcut menu: main menu , record mode, playback, PTZ control, high speed PTZ, color setting, output adjust, logout,view and spot. Among which, PTZ control and color setting only can apply for current selected channel. If you are in multiple-window mode, system automatically switches to the corresponding channel.
	Exit current menu without saving the modification.
Press middle button	In numeral input box: Increase or decrease numeral value.
	Switch the items in the check box.
	Page up or page down
Move mouse	Select current control or move control
Drag mouse	Select motion detection zone
	Select privacy mask zone.

4.4 Remote Controller

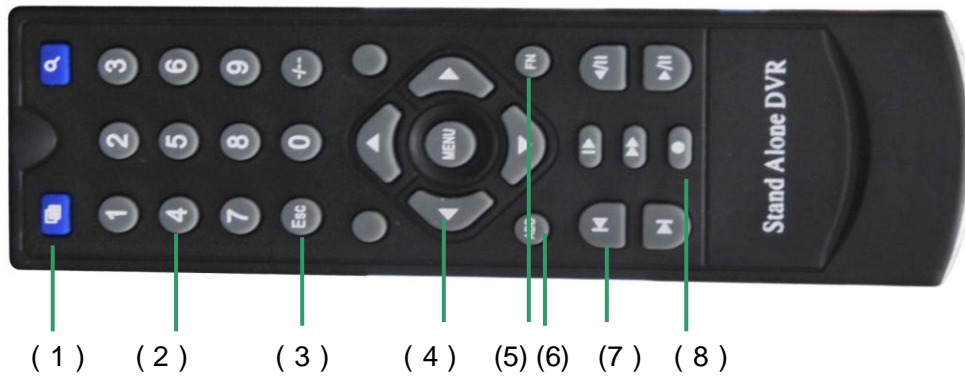

Serial number	Name	Function
1	Multi-window button	Same function as Multi-window button in the system
2	Numeric button	Code input, number input & channel switch
3	【ESC】	Same function as 【ESC】 button in the front panel
4	Direction button	Same function as direction button in the front panel
5	FN	Assistant function
6	ADD	Input the number of NVR to control it
7	Record control	Control the record
8	Record mode	Same function as "Record mode"

Contents

1. NVR INSTALLATION.....	8
HDD INSTALLATION	8
2. LOGIN.....	9
2.1 SYSTEM BOOT UP	9
2.2 LOGIN.....	9
3. SYSTEM INTRODUCTION	10
3.1 SYSTEM MENU TREE	10
3.2 MAIN MENU	11
3.3 SHORTCUT MENU	14
4. OPERATION OF MAIN MENU	15
4.1 RECORD	15
4.2 ALARM.....	17
4.3 SYSTEM.....	21
4.4 ADVANCED	27
4.5 INFO.....	31
4.6 LOGOUT.....	33
5. RECORD MODE	33
6. PLAYBACK	34
7. PTZ CONTROL.....	34
8. ALARM OUTPUT	36
9. OUTPUT ADJUST	36
10. LOGOUT	36
ADDENDA A FAQ.....	37

1. NVR Installation

Note: please carefully read those warning and any query please contact us.

1. Before installation, please open the package and check all the components listed.
2. All installation and operation here should conform to local electrical safety codes.
3. The NVR should be installed in a cool, dry place away from direct sunlight, inflammable, explosive substances and etc. Heavy stress, violent vibration or water splash are not allowed during transportation, storage and installation.

HDD Installation

NVR need install HDD first, 4 HDD could be installed into NVR enclosure and the maximum is 2TB, we recommend high-speed HDD 7200rpm or higher, and the SATA cable already connected the SATA ports of NVR main board.

1. Loosen the screws on the left and right side of the cover.
2. Open the cover.
3. Use NVR main board SATA data cable to connect to the SATA ports of HDD, and then connect power cord to the HDD.
4. Use the provided HDD screws to fix HDD on the bottom case.
5. Close the NVR enclosure and screw firmly.



2. Login

2.1 System Boot up

Connect the power supply, indicator light is on and NVR boots up.

2.2 Login

When the system boots up, Click OK button or right click mouse, you can see the login interface. There are 2 default users: "admin" "guest". "Admin" users have administrator right. The default password is empty for all 2 default users' account. "Guest".user only can review playback.

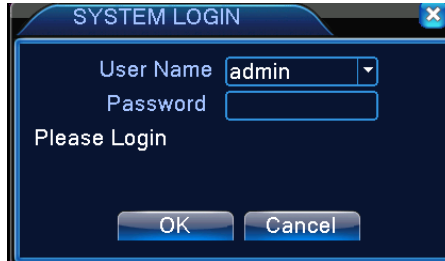

Password protection: you can input password 5 times within 30 minutes, otherwise the account will be locked. When the account is locked, user has to wait for another 30 minutes to login the system again.

Note: please don't directly power off the system when NVR has HDD.

For your system security, please modify your password after first time login. Please go to **Main Menu → Advanced → Account → Modify pwd.**

You can use USB mouse or remote controller to input password. About input method:

Click  to switch between numeral, English character (small/capitalized), Chinese characters and special sign.

System Shutdown

Note: please make sure the power of system is off before change the HDD.

Method 1: Main menu → Logout.

Method 2: Right click mouse → Logout.

Auto Resume after Power Failure

The system can automatically backup video and resume previous working status after power failure.

Replace Button Battery

Please make sure to use the same battery model if possible.

We recommend replacing battery regularly (such as one year) to guarantee accuracy system time.







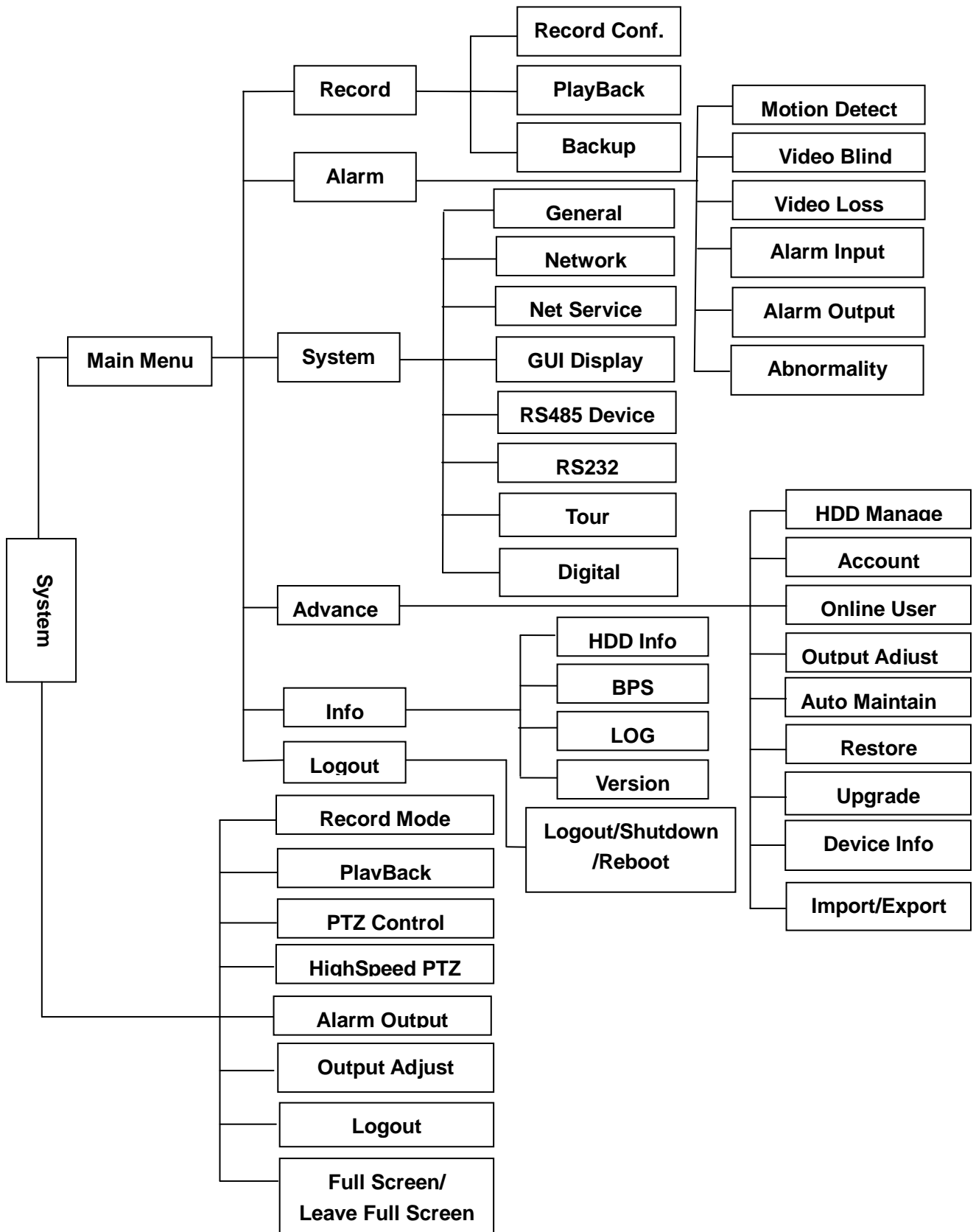



For example, when we changed the resolution setting we can not save it then we need to change the cell battery.











3. System Introduction

3.1 System Menu Tree





3.2 Main menu

Main Menu	Sub Menu	Function
Record 	Record Conf. 	Configure the recording time.
	PlayBack 	Search for and playback recorded video files.
	Backup 	Backup the files to backup device.
Alarm 	Motion Detect 	Configure all video detection parameters.
	Video Blind 	Set video blind detect parameters.
	Video Loss 	Set video loss parameters.
	Alarm Input 	Include channel, enable, alarm input type, arming time, period, interval, alarm output, output time delay, record channel, tour, PTZ activation, delay, show message, FIP upload etc.
	Alarm Ouput 	Alarm mode, setting, on/off and status.
	Abnormality 	Abnormal paramerters setup.

<p>System</p> 	<p>General</p> 	<p>Configure system time, time format, language, recording in HDD, series number, video system, auto logout time, machine name, etc.</p>
	<p>Network</p> 	<p>Setup network parameters: IP address, subnet mask, gateway, primary DNS, secondary DNS, media port, HTTP port etc.</p>
	<p>Net Service</p> 	<p>Display net server and net server information: PPPoE, NTP, email, IP filter, DDNS, FTP, ARSP, mobile monitor and UPNP.</p>
	<p>GUI Display</p> 	<p>Setup GUI and monitoring parameters: front output, coding output, masking, etc.</p>
	<p>RS485 Device</p> 	<p>Setup control protocols and bit rate.</p>
	<p>RS232</p> 	<p>Setup series port and bit rate.</p>
	<p>Tour</p> 	<p>Setup touring parameters.</p>
	<p>Digital</p> 	<p>Settings for channel mode.</p>
		<p>HDD Manage</p> 
	<p>Account</p> 	<p>Setup user group and account.</p>

<p>Advanced</p> 	<p>Online User</p> 	Display online users.
	<p>Output Adjust</p> 	To adjust the position and color of video output.
	<p>Auto Maintain</p> 	Auto reboot system and auto delete old files.
	<p>Restore</p> 	Restore system parameters to the factory default mode. Note: Not for user account.
	<p>Upgrade</p> 	Upgrade software for this device.
	<p>Device Info.</p> 	Configure the device hardware information: Audio & alarm in channel, alarm out channel, GUI theme, remote control type, etc.
	<p>Import/Export</p> 	Set the files' name, and then click import or export.
<p>Info</p> 	<p>HDD Info</p> 	SATA connection state, information for all installed disk.
	<p>BPS</p> 	Each channel's bit rate and occupied HDD capacity per hour.

	LOG 	Display important event log and designate needed log.
	Version 	Display system hardware, software version and release date, etc.

3.3 Shortcut Menu

Menu	Main Menu	Enter main menu system.
	Record Mode	Set record mode: schedule/manual/stop.
	PlayBack	Record video inquiry and playback.
	PTZ Control	PTZ control protocols and bit rate.
	High Speed PTZ	Drag the mouse to control the turning direction of PTZ camera.
	Alarm Output	Set alarm type, configuration, manual, stop and status.
	Output Adjust	Adjust picture's up, down, left, right deflate.
	Logout	Include logout, shutdown and reboot.
	Full Screen/ Leave Full Screen	Change the view size.

1		The logo displays on the screen when recording occurs.	2		The logo displays on the screen when motion detection occurs.
3		The logo displays on the screen when video loss occurs.	4		The logo displays on the screen when camera masking occurs.

4. Operation of Main Menu

Main menu includes: record, alarm, system, advanced, info and logout.

Enter main menu method:

1. Press OK button on the panel to enter main menu directly.
2. Press MENU button on the panel to enter main menu directly.

4.1 Record

4.1.1 Record Conf.

Note: user should have “Record” authority, HDD should be installed and format properly.



Channel: click the corresponding channel. Choose “all” option to set the entire channels.

Redundancy: select the recording file and backup in two hard disks. One is read-write disk; the other one is redundant disk.

Length: set the time length of each video file.

Prerecord: prerecord before the action. (File length is decided by the code stream)

Mode: set the record mode. There are three types, schedule, manual & stop.

Week: user can select from Saturday to Sunday or all to record.

Period: set recording type: regular, detect or alarm. User can select any time you want to record and press OK button.

When record configure window displays on the screen, right click mouse or click “Advanced” button the following shortcut will pop up.

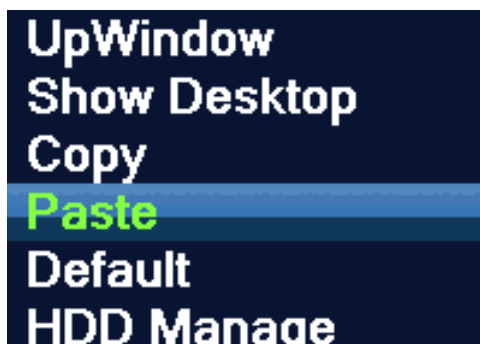

Upwindow: left click it will return to last window.

Show desktop: left click it will return to live video window.

Copy & paste: user can copy one channel’s setting to paste to other channels for setting the same parameters of other channels.

Default: left click it and current parameters configure will go back to the default mode.

HDD Manage: left click it will go to HDD Manage interface.

4.1.2 PlayBack

Search for and playback recorded video files. Choose one channel and the date to

playback and then click  to set the start time and end time, after this, please click



to scan the playback video. The time bar is at the bottom and it will display the time speed and interval. Drag the mouse and left click to quick or slow the play time.

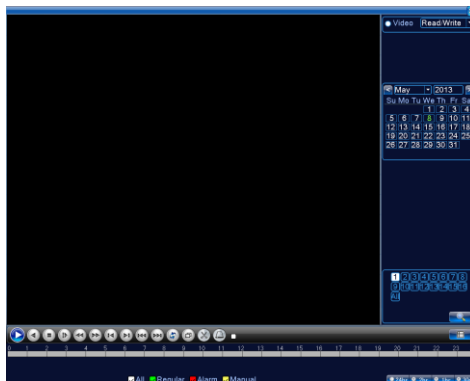

The control bar instructions:



: Click this button to start to playback.



: First click this button, it will rewind the video , click again it will pause the slow playback.



: Stop playbacking the video.



: Slowly play the files.



: Fast play the files.



: Previous frame. Click to replay the previous file.



: Next frame. Click to replay the next file.



: Previous file (it only works when the playback is paused).



: Next file (it only works when the playback is paused).



: To circulate the playback.

4.1.3 Backup

Click the option to finish what you want, for example, choose Backup to backup the recorded files to local storage device. (Support USB storage devices, support FAT32, NTFS.)

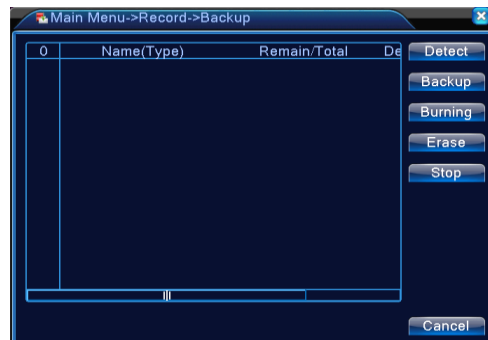

4.2 Alarm

4.2.1 Motion Detect

Choose the channel and click Enable, and then set the below parameters and click the responding channel. After finish these step, just click Advanced.

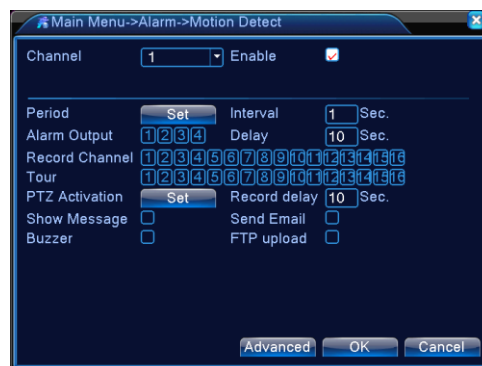

Period: click set button, you can see an interface is shown as below. Here you can set for business day and non-business day. You can set up four time period, but they can't be repeated.

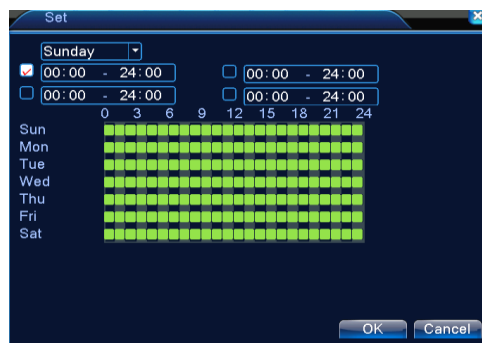

Record Channel: select the channel to activate recording function once alarm occurred.
Note: Please make sure you have set schedule record mode in Record Config.interface.

(Main Menu → Record → Record Config.→ Schedule)

Tour: here you can enable tour function when alarm occurs. It is a one-window tour.

PTZ activation: here you can set PTZ movement when alarm occurs. Such as go to preset, tour & pattern when there is an alarm. Click “set” button.

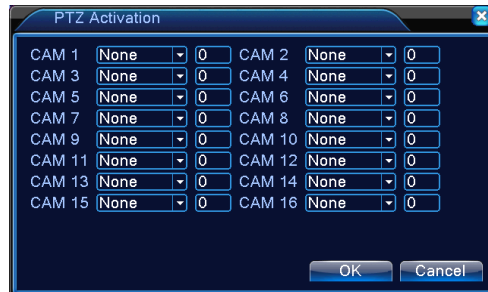

Delay: when motion detection completes, system auto delays recording for a specified time.

Show message: there is connection motion on the screen when alarm signal happens.

Send Email: default mode is “off”. If user ticks this function, when alarm signal happens system will send email to user’s default mail account.

Buzzer: default mode is “off”. If user ticks this function, when alarm signal happens it will buzzer.

FTP upload: If user ticks this function, when alarm signal happens it will upload to net server.

When motion detect configure window displays on the screen, right click mouse or click “Advanced” button the following shortcut will pop up and left click each icon will go to relative applications.

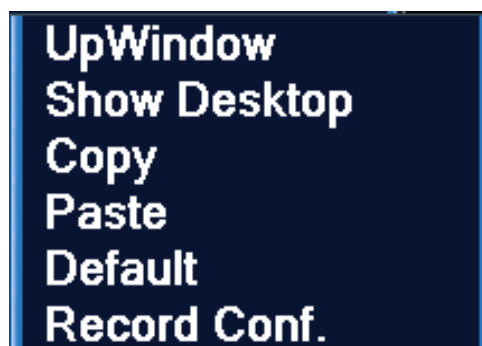

4.2.2 Video Blind

Choose one channel and click Enable. User can set the parameters for video blind. The function of each item is the same as that of Motion Detect. When someone viciously masks lens, the system can alert you to guarantee video continuity.

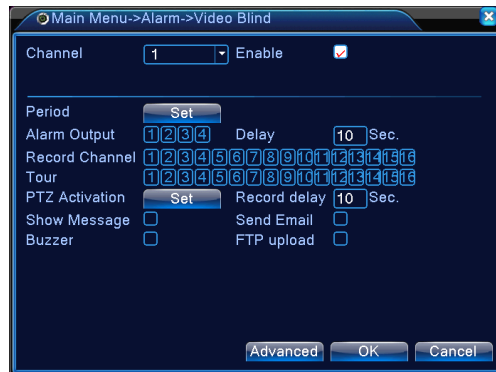

4.2.3 Video Loss

The function of each item is the same as that of Motion Detect. When video loss happens, the system will give user the video loss alarm. User can select video loss show information in local mainframe screen.

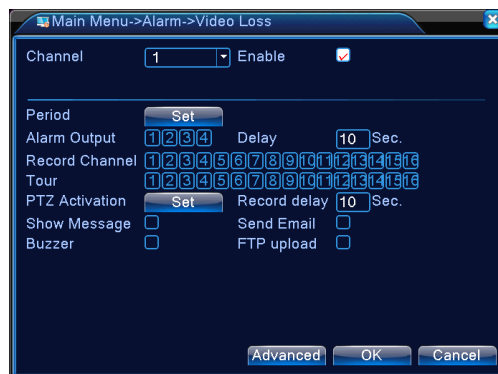

4.2.4 Alarm Input

Choose the channel of alarm in and Click the Enable and then set the below parameters. After finish these steps, click Advanced.

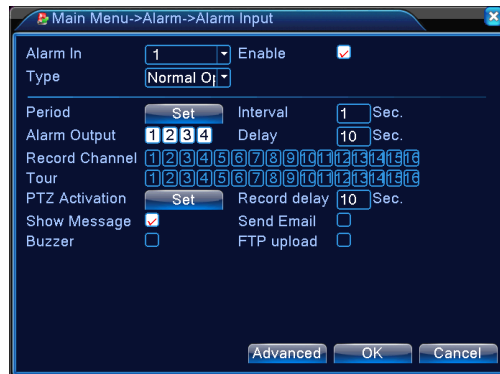

4.2.5 Alarm Output

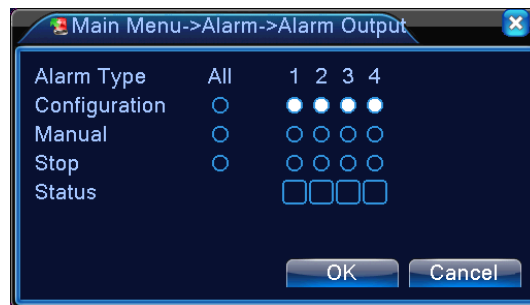

4.2.6 Abnormality

User can set up the parameters of abnormality as you request.

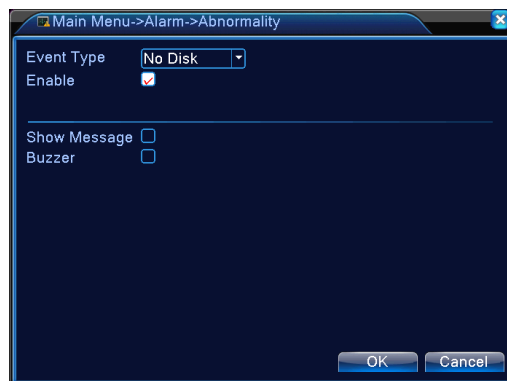

4.3 System

4.3.1 General

User can set the time, language and remote control address.

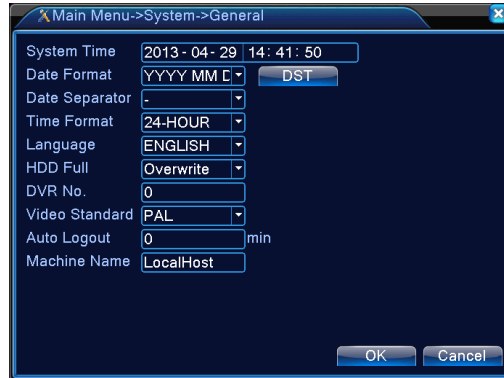

System time: here is for you to set system time.

Date format: there are three types. “Y” is for “year”, “M” is for “month”, “D” is for “day”.

DST: Click Enable so you can set DST time and date and then click OK button.

Date separator: there are three denotations to separate date: dot, beeline and solidus.

Time format: 24-hour and 12-hour.

Language: system supports some language. Choose the one you like.

HDD full: here is for you to select working mode when hard disk is full. There are two options: stop record or overwrite.

Stop or rewrite may be selected while no space for the disk. The condition of stopping recording is the present working disk is full or under covering and the next disk is non-empty. The condition of rewrite is the present working disk is full and the next disk is non-empty.

NVR No: when you are using one remote control to control several NVRs, you can give a name to each NVR for your management.

Video standard: there are two formats: NTSC and PAL.

Auto Logout: here is for you to set proper user’s operation duration. Value ranges from 0 to 60 Minutes. User has to re-login the system after time out.

Machine Name: the default is Localhost.

4.3.2 Network

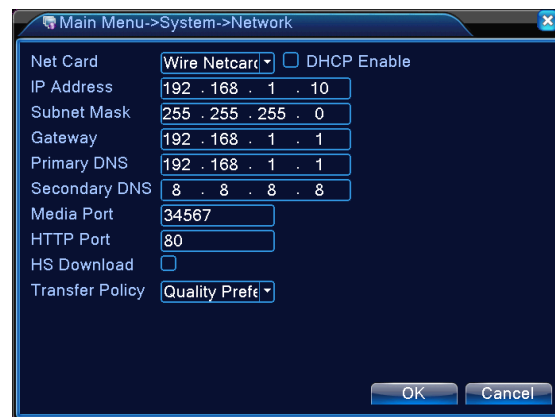

Net card: wire Netcard.

DHCP Enable: normally user do not need to highlight it, highlight means select Dynamic Host Configuration Protocol.

IP address: the default address is 192.168.1.10, left click the numeral in the on-screen keyboard directly to modify it.

Subnet mask: the default address is 255.255.255.0, left click the numeral in the on-screen keyboard directly to modify it.

Gateway: the default address is 192.168.1.1, left click the numeral in the on-screen keyboard directly to modify it.

Primary DNS and Secondary DNS: the same setting as the router DNS.

Media Port: configurable according to user's demand.

HTTP port: configurable according to user's demand.

HS download: system can process the downloaded data fast if you enable this function.

Transfer Policy: here you can select the priority between fluency/video qualities: Adaptive/Quality Preferred/ Fluency Preferred.

4.3.3 Netservice

There are several submenus to select: PPPoE, NTP, EMAIL, IP FILTER, DDNS, FTP, ARSP, Alarm Server, Mobile Monitor, etc. Choose one title and click Set to set the corresponding parameters.

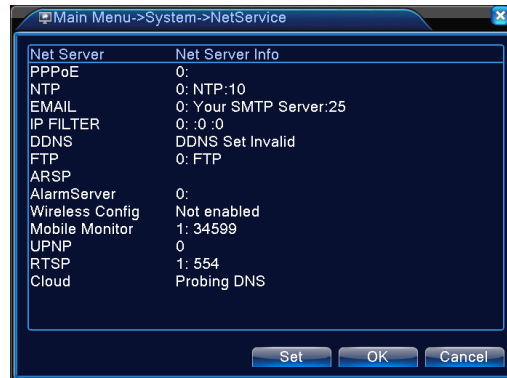

PPPoE

Choose Enable and input the user name, password and IP address.

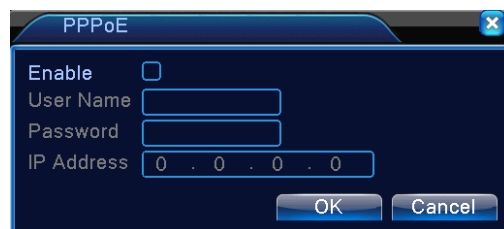

DDNS

Choose DynDns and tick the Enable and then input the Domain name, user name and password. After it, click OK.



Mobile Monitor

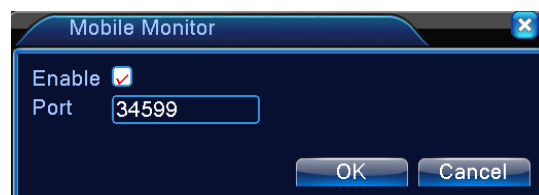

4.3.4 GUI Display

Click this button. The interface will be shown as belows, including channel Title, time display, record status, alarm status and so on.

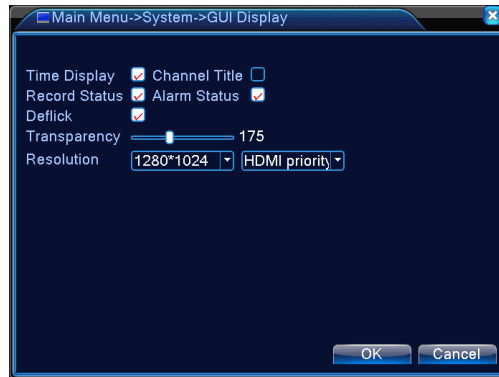

Channel Title: click set button to set each camera's name.

About time display, channel title, record status and alarm status user can highlight each one according to requirement then these relative icons will display on the live video windows.

Time Display: you can select to display time by IE or playback. Highlight and tick means select.

Deflick: highlight and tick means select it.

Transparency: here is for you to adjust picture's transparency. The value ranges from 128 to 255.

Resolution: 1024*768, 1280*720, 1280*1024, 1920*1080 and 1440*900. Choose 1280*1024 and HDMI priority.

4.3.5 RS485 Device



Protocol: select corresponding PTZ protocol, 15 protocols embedded. Select the corresponding RS485 device.

Address: RS485 device Address.

Baud rate: select corresponding baud rate.

Data bits: select corresponding data bits.

Stop bits: select corresponding stop bits.

Parity: there are four options: odd/even/mark/space.

Note: please make sure that protocol, address and baud rate fit with PTZ camera protocol, address and baud rate. Otherwise camera cannot be controlled.

4.3.6 RS232

Choose this item and set the corresponding parameters to realize the remote control.

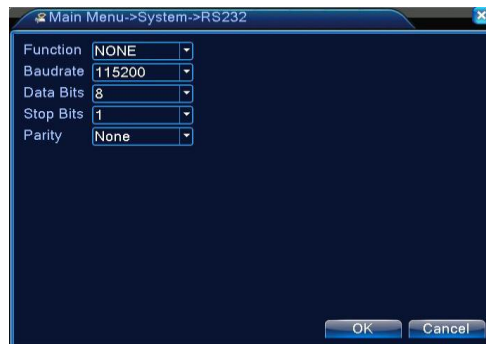

4.3.7 Tour

Set tour and time, interval is 5-120s, includes single picture, 4 pictures, 8 pictures and 9 pictures.

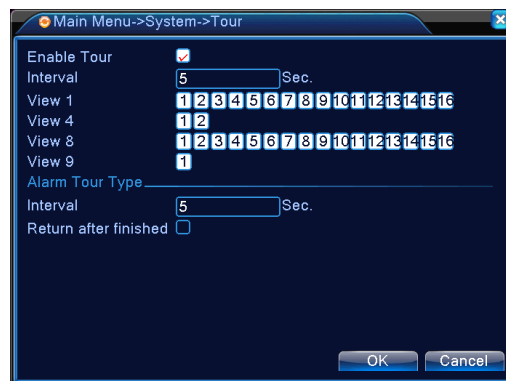

4.3.8 Digital

There are three items: Digital channels, Channel status and ChannelType.

Digital channels

Here you can firstly add the device for monitoring. Choose the channel and set the below parameters and then click Add.

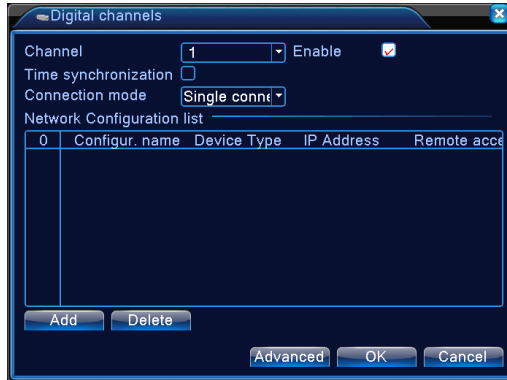

Channel: choose the channel that you want to add for monitoring.

Enable: click this to set the below parameters.

Time synchronization: click this to monitor several pictures at the same time.

Connection mode: you can choose Single connection to monitor one picture or choose Multi-link to monitor several pictures at the same time.

After click Add, you will see the below picture and set the parameters.

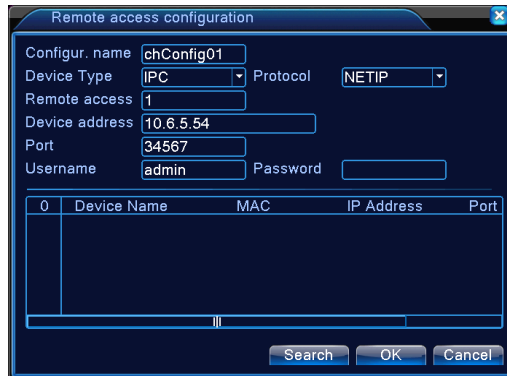

Configur. Name: choose the channel you want to configure.

Device Type: you can choose IP Camera, NVR or HVR to add for monitoring.

Protocol: you can choose NETIP or ONVIF. When you use NVR for monitoring, choose ONVIF.

Device address: After you set the above parameters, click Search and it will appear some device names and their address in the blank of the rectangle. Double click one and the device address will appear in this area. Input the password (the default is empty) and Click OK.

Channel status

Here you can scan the channel status, including Max. resolution, This Resolution and Connection Status.

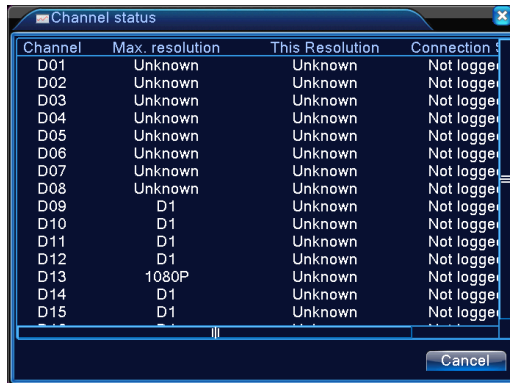

ChannelType

Here you can see the NVR mode.

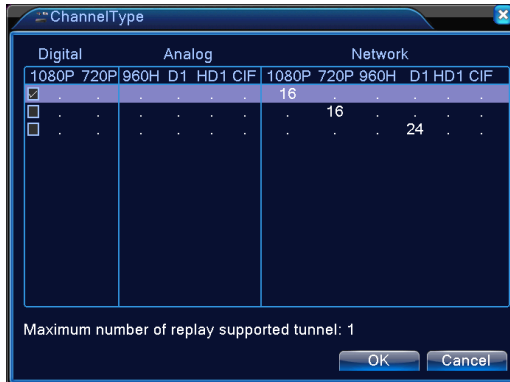

4.4 Advanced

4.4.1 HDD Management

User can manage the HDD data.

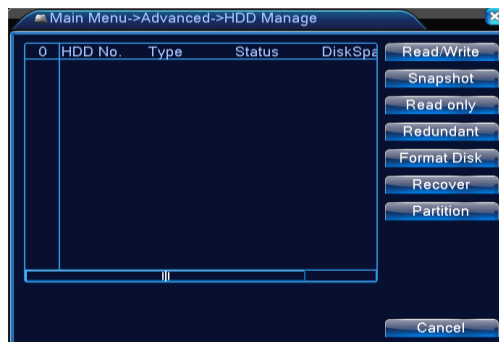

Support 4 SATA HDD. If select HDD, it displays current type, total capacity, and record time. User can modify HDD attribute, read-only disk, read-write disk, redundancy disk or delete all the data in the HDD. After all the setups please click OK button, system goes back to the previous menu.

4.4.2 Account

You can manage the user account, including Modify User, Modify Group, Modify Pwd, Add User, Add Group, Delete User, Delete Group and Update.



Modify User

Here is to modify User name. Input the old user name in the first square and the new user name in the second one. Tick Reusable and click OK.



Modify Pwd

Here is to modify the password. Input the user name and the old password, and then input the new password twice. Click OK.

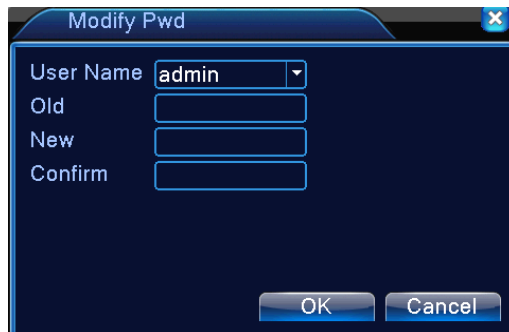

Note:

The user name and group name can consist of six bytes: characters, number, underline, subtraction sign, dot, other characters are not allowed.

System account adopts two-level management: group and user. No limit to group or user amount.

For group or user management, there are two levels: admin and user.
User management adopts group and user 2 class ways, group name can not repeat, user name can not repeat, each user must belong to certain group; one user can belong to one group only.
One user should belong to one group. User right can not exceed group right.

4.4.3 Online User

Through LAN to view visitors



4.4.4 Output Adjust

Adjust picture's up, down, left, right deflate. Please drag slide bar to adjust each item, adjust range value from 0 ~ 100, default value 0.

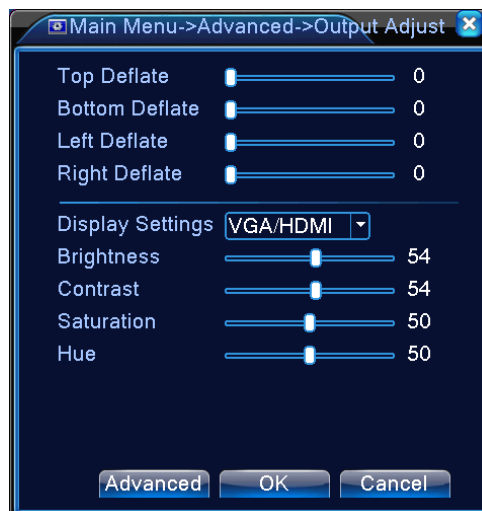

4.4.5 Automaintain

Here you can set auto-reboot system and auto-delete old files setup.

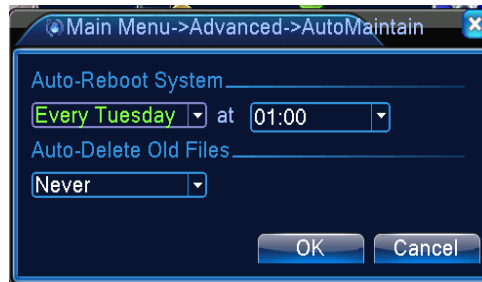

4.4.6 Restore

Restore system parameters to the factory default. Including general, encode, record conf., alarm set, network, netservice, GUI display, RS232, and account.



4.4.7 Upgrade

Connect to the USB port on the rear panel with the USB device, which has upgrade file, and then select the file to upgrade. The upgrade includes kernel, u-boot, setting, applications and file system.

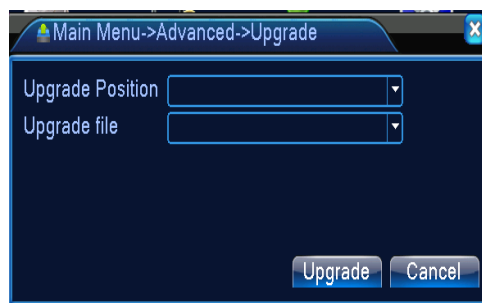

4.4.8 Device Info

Set the parameters and click the Enable RS232 and Enable PTZ to support remote control.

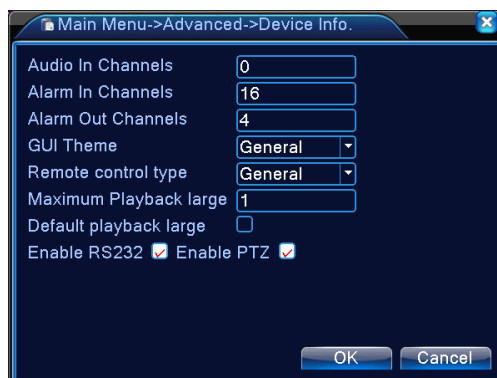

4.4.9 Import/Export

Set the Device Name and File Name to import or export.



4.5 Info

4.5.1 HDD Information

SATA connection states: information for all installed disks.

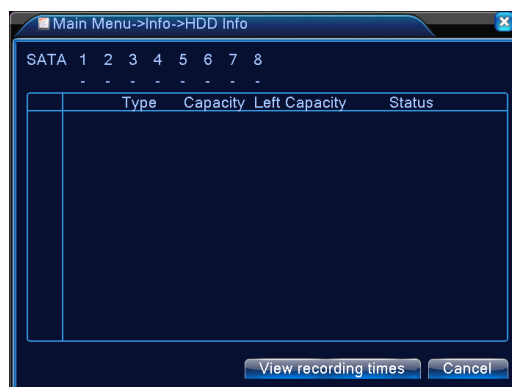

Here is to list hard disk type, capacity, left capacity and status.

After system start, if there is conflict, will jump to HDD information page immediately, user

can check the system time and HDD time, If conflict please enter normal setup to modify system time, or enter advanced HDD management to format HDD, then restart device.
 Note: means current HDD is normal. X means there is error. - Means there is no HDD. If disk is damaged, system shows as “?”. Please remove the broken hard disk before you add a new one.

4.5.2 BPS

Here is for you to view current video data stream (KB/s) and occupied hard disk storage. (MB/h)

Channel	Kb/S	MB/H	Channel	Kb/S	MB/H
1	0	0	9	0	0
2	0	0	10	0	0
3	0	0	11	0	0
4	0	0	12	0	0
5	0	0	13	0	0
6	0	0	14	0	0
7	0	0	15	0	0
8	0	0	16	0	0

4.5.3 LOG

Type: Search

Start Time: Search

End Time: Next Page

64	Log Time	Type	LOG
1	2013-04-29 09:40:48	Reboot	2013- 4-26 14:24
2	2013-04-29 09:40:48	Log In	User default LogI
3	2013-04-29 09:42:05	Log Out	User default LogO
4	2013-04-29 09:42:05	Log In	User admin LogI
5	2013-04-29 10:33:33	Shut Down	2013- 4-29 10:33
6	2013-04-29 10:38:11	Reboot	2013- 4-29 10:33
7	2013-04-29 10:38:11	Log In	User default LogI
8	2013-04-29 10:38:31	Log Out	User default LogO
9	2013-04-29 10:38:31	Log In	User admin LogI
10	2013-04-29 10:45:43	Save Configuration	Digital channel

Remove Cancel

Here is for you to view system log file. System lists the following information.
 Log types include all, system, config, storage, alarm event, week day, account, playback.
 Pleased select start time and end time, then click search button. You can view the log files.
 Please page up/down button to view if there are more than ten files.

4.5.4 Version

Display system hardware's feature, software version and issue date etc.

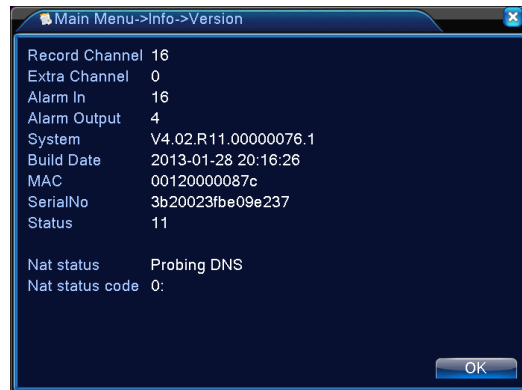

4.6 Logout



Logout: exit menu, and you need to provide password again when entering the menu next time.

Shut down: logout system turns off power.

Reboot: system begins rebooting.

Note: when push the power switch button, it will appear a confirmation progress bar, after shutting down 3 seconds, it still can be cancelled during progress. User has to input password to exit.

5. Record Mode

Here is to see the record mode.

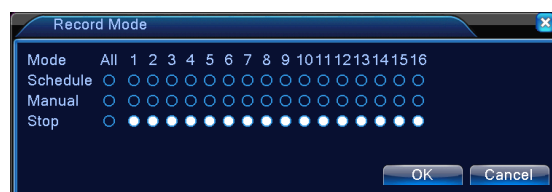

6. Playback

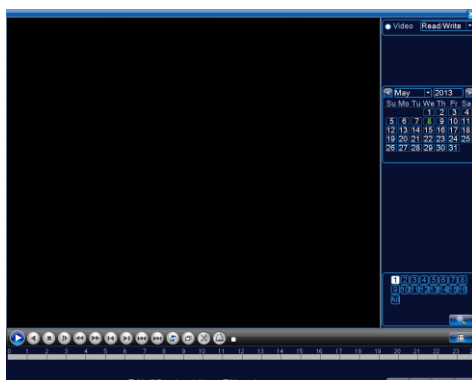

Refer to the operation of **Main Menu** → **Record** → **Plackback**.





7. PTZ Control



Speed: mainly to control direction. For example, step 8 is much faster than step 1. (Input the number 1~8 through mouse click, and 8 is the fastest.)

Click  and  to adjust zoom, focus and iris value.

Please click direction arrows to adjust PTZ position. There are total 8 direction arrows: up, down, left, right, left-up, right-up, left-down and right-down. (Up, down, left, right only use when using front panel)

Name	Function key	function	Shortcut key	Function key	function	Shortcut Key
Zoom		Near	▶	▶	Far	▶▶
Focus		Near	◀	◀	Far	▶
Iris		close	◀◀	◀◀	Open	▶▶

Click the “set” button. The interface is shown as below. Here you can set the following items: Preset, Tour, Pattern, and Border.



On PTZ main menu press Page Switch button and the interface is shown as below.



Activate Patrol (tour)

Input patrol (tour) number in the No. blank and click patrol button.

Pattern Setup

Input mode value in the No. blank, and click pattern button.

Activate Auto Scan

Click "Auto Scan" button, the system begins auto scan. Correspondingly, the auto scan button becomes to stop button. Click stop button to terminate scan operation.

Note: preset, tour and pattern all need the value to be the control parameter. You can define it as you require. You need to refer to your speed dome user's manual for Aux definition. In some cases, it can be used for special process.

8 Alarm Output

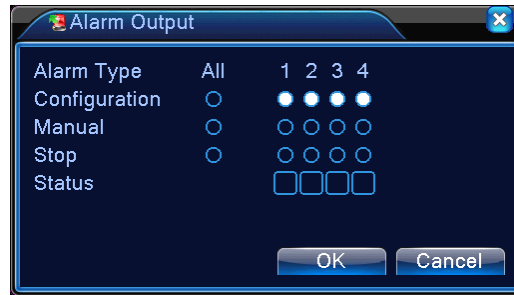

9. Output Adjust

Adjust picture's top, bottom, left, right deflate. Please drag slide bar to adjust each item, adjust range value from 0~100, default value 0. (Referred to Main Menu → Advanced → Output Adjust)



10. Logout

There are three modes to choose: logout, shutdown and reboot.

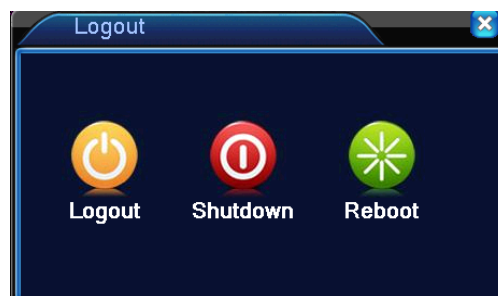

Addenda FAQ

1. NVR cannot boot up properly.

There are following possibilities:

- Input power is not correct
- Power connection is not correct
- Power switch button is not correct
- Program upgrade is wrong
- HDD malfunction or something wrong with HDD ribbon
- Front panel error
- Main board is damaged

2. Remote control does not work.

There are following possibilities:

- Remote control address is not correct
- Distance is too far or control angle is too small
- Remote control battery power is low
- Remote control is damaged or NVR front panel is damaged
- Check if the system is lockup, login again

3. NVR often automatically shuts down or stops running.

There are following possibilities:

- Input voltage is not stable or it is too low
- HDD malfunctions or something wrong with the ribbon
- Button power is not enough
- Front video signal is not stable
- Working environment is too harsh, too much dust
- Hardware malfunction

4. System cannot detect hard disk.

There are following possibilities:

- HDD is broken
- HDD ribbon is damaged
- HDD cable connection is loose

5. There is no video output whether it is one channel, multiple channels or all channels output.

There are following possibilities:

- Program is not compatible, please upgrade to the latest version
- Brightness is 0, please restore factory default setup
- There is no video input signal or it is too weak
- Check privacy mask setup or your screen saver
- NVR hardware malfunction

6. Real-time video color is distorted.

There are following possibilities:

- When using BNC output, NTSC and PAL setup is not correct. The real-time video becomes black and white
- NVR and monitor resistance is not compatible

-
- Video transmission is too long or degrading is too huge
 - NVR color or brightness setup is not correct

7. Cannot search local records.

There are following possibilities:

- HDD ribbon is damaged
- HDD is broken
- Upgraded program is not compatible
- The recorded files have been overwritten
- Record function has been disabled

8. Video is distorted when searching local records.

There are following possibilities:

- Video quality setup is too low
- Program read error, bit data is too small, there is mosaic in the full screen, please restart the NVR to solve this problem
- HDD data ribbon is damaged
- HDD malfunction

9. There is no audio when monitor.

There are following possibilities:

- It is not a power picker
- It is not a power acoustics
- Audio cable is damaged
- NVR hardware malfunctions

10. It has audio when monitor but there is no audio when system playback.

There are following possibilities:

Setup is not correct, please enable audio function

Corresponding channel has no video input, and playback is not continuous when the screen is blue

11. Time display is not correct.

There are following possibilities:

- Setup is not correct
- Battery contact is not correct or voltage is too low
- Crystal is broken

12. NVR cannot control PTZ.

There are following possibilities:

- Front panel PTZ error
- PTZ decoder setup, connection or installation is not correct
- Cable connection is not correct
- PTZ setup is not correct
- PTZ decoder and NVR protocol, address and baudrate is not compatible
- When there are several decoders, please add 120 Ohm between the PTZ decoder A/B cables furthest end to delete the reverberation or impedance matching
- The distance is too far

13. Motion detection function does not work.

There are following possibilities:

-
- Period setup is not correct
 - Motion detection zone setup is not correct
 - Sensitivity is too low
 - For some versions, there is hardware limit

14. Cannot log in client-end or web.

There are following possibilities:

- Network connection error
- Network setup error
- Password or user name is invalid
- Client-end is not compatible with NVR program

15. There is only mosaic no video when preview or playback video file remotely.

There are following possibilities:

- Network fluency is not good
- Client-end resources are limits
- There is multiple-cast group setup in NVR, this mode can result in mosaic, usually we do not recommend this mode
- There is privacy mask or channel protection setup
- Current user has no right to monitor
- NVR local video output quality is not good

16. Network connection is not stable.

There are following possibilities:

- Network is not stable
- IP address conflict
- MAC address conflict
- PC or NVR network card is not good

17. Alarm signal cannot be disarmed.

There are following possibilities:

- Alarm setup is not correct
- Alarm output has been open manually
- Input device error or connection is not correct
- Some program versions may have this problem, please upgrade your system

18. Alarm function is null.

There are following possibilities:

- Alarm setup is not correct.
- Alarm output has been open manually
- Input devices error or connection is not correct
- Alarm input signal is not correct

19. Record storage period is not enough.

There are following possibilities:

- Camera quality is too low. Lens are dirty, camera is installed against the light. Camera aperture setup is not correct
- HDD capacity is not enough
- HDD is damaged

20. Cannot playback the downloaded file.

There are following possibilities:

- There is no media player
- No DXB8.1 or higher graphic acceleration software
- There is no DivX503 Bundle.exe control when you play the file transformed to AVI via media
- No DivX503Bundle.exe or ffdshow-2004. Exe in windows XP OS

21. Forget local menu operation password or network password.

Please contact your local service engineer or our salesperson for help. We can guide you to solve this problem.